

3x4 MATRIX LED DRIVER

DESCRIPTION

The IS31FL3740 is a general purpose 3x4 LEDs matrix driver with 1/12 cycle rate. The device can be programmed via an I2C compatible interface. Each LED can be dimmed individually with 8-bit × 8 PWM data which allowing 1024 steps of linear dimming.

IS31FL3740 features 3 Auto Breathing Modes which are noted as ABM-1, ABM-2 and ABM-3. For each Auto Breathing Mode, there are 4 timing characters which include current rising / holding / falling / off time and 3 loop characters which include Loop-Beginning / Loop-Ending / Loop-Times. Every LED can be configured to be any Auto Breathing Mode or No-Breathing Mode individually.

FEATURES

- Up to 12 LEDs (3x4) in dot matrix
- Programmable 3x4 (4RGBs) matrix size with de-ghost function
- Selectable 3 Auto Breath Modes for each dot
- Auto Breath Loop Features interrupt pin inform MCU Auto Breath Loop completed
- Auto Breath offers 128 steps gamma current, interrupt and state lookup registers
- 256 steps Global Current Setting
- Individual 1024 PWM control steps
- Individual Auto Breath Mode select
- Individual open and short error detect function

QUICK START



Figure 1: Photo of IS31FL3740 Evaluation Board

(V01A board with 12V DC input please refer to appendix I)

RECOMMENDED EQUIPMENT

- 5.0V, 2A Micro USB
- Arduino IDE, www.arduino.cc/en/Main/Software
- Arduino code download from ISSI website

ABSOLUTE MAXIMUM RATINGS

- ≤ 5.5V Micro USB DC power supply

Caution: Do not exceed the conditions listed above, otherwise the board will be damaged.

PROCEDURE

The IS31FL3740 evaluation board is fully assembled, tested and comes programmed with evaluation software. Follow the steps listed below to verify board operation.

Caution: Do not turn on the power supply until all connections are completed.

- 1) Connect the 5VDC USB power to the Micro USB.
- 2) Press K1 to cycle through a display mode.

EVALUATION BOARD OPERATION

The IS31FL3740 evaluation board drives 8 RGB LEDs located underneath the light dispersing filter. Every press of the K1 switch will cycle through one of the 8 pre-programmed lighting sequences below:

- 1) Changing color mode 1
- 2) Changing color mode 2
- 3) Pink color
- 4) Yellow color
- 5) Cyan Color
- 6) White color
- 7) Red color
- 8) Blue Color
- 9) Green color

Note: IS31FL3740 solely controls the FxLED function on the evaluation board.

ORDERING INFORMATION

Part No.	Temperature Range	Package
IS31FL3740-QFLS4-EB	-40°C to +125°C (Industrial)	QFN-20, Lead-free

Table 1: Ordering Information

For pricing, delivery, and ordering information, please contacts ISSI's analog marketing team at analog@issi.com or (408) 969-6600.

3x4 MATRIX LED DRIVER

SOFTWARE CONTROL

The evaluation board comes with an Arduino compatible microcontroller circuit preloaded with IS31FL3740 demonstration firmware, called a sketch. This allows the functionality of the IS31FL3740 to be verified before starting firmware development.

The Arduino hardware consists of an Atmel microcontroller with a bootloader allowing quick firmware updates. First download the latest Arduino Integrated Development Environment IDE (1.6.12 or greater) from www.arduino.cc/en/Main/Software. Then download the latest IS31FL3740 firmware (sketch) from the ISSI website www.issi.com/US/product-analog-automotive.shtml. When using the Arduino environment, please select Genuino UNO as shown below, then select the serial port. Follow the standard procedure to upload the latest IS31FL3740 firmware into the Arduino; then use the IDE to modify it. There is no additional software required to run the eval board.

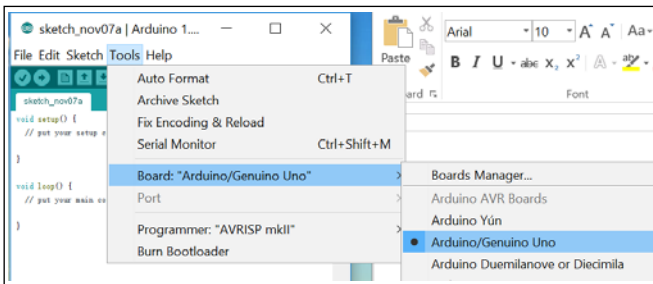

EXT-SOFTWARE CONTROL

The IS31FL3740 can also be driven by an external I2C source.

Follow the steps below to configure the eval board for external control.

- 1) Open the two pins of J7 on the right side, to disable the onboard Arduino and enable external control (the SDA SCL and SDB become high impedance).
- 2) Default VIO is 5V, if you use a 3.3V IO, connect 3.3V to VIO pin in J7.
- 3) Connect SDB to VIO or high level IO
- 4) Connect external I2C to the I2C pins of J7
- 5) Start external I2C control.

Please refer to the datasheet to get more information about IS31FL3740.

3x4 MATRIX LED DRIVER

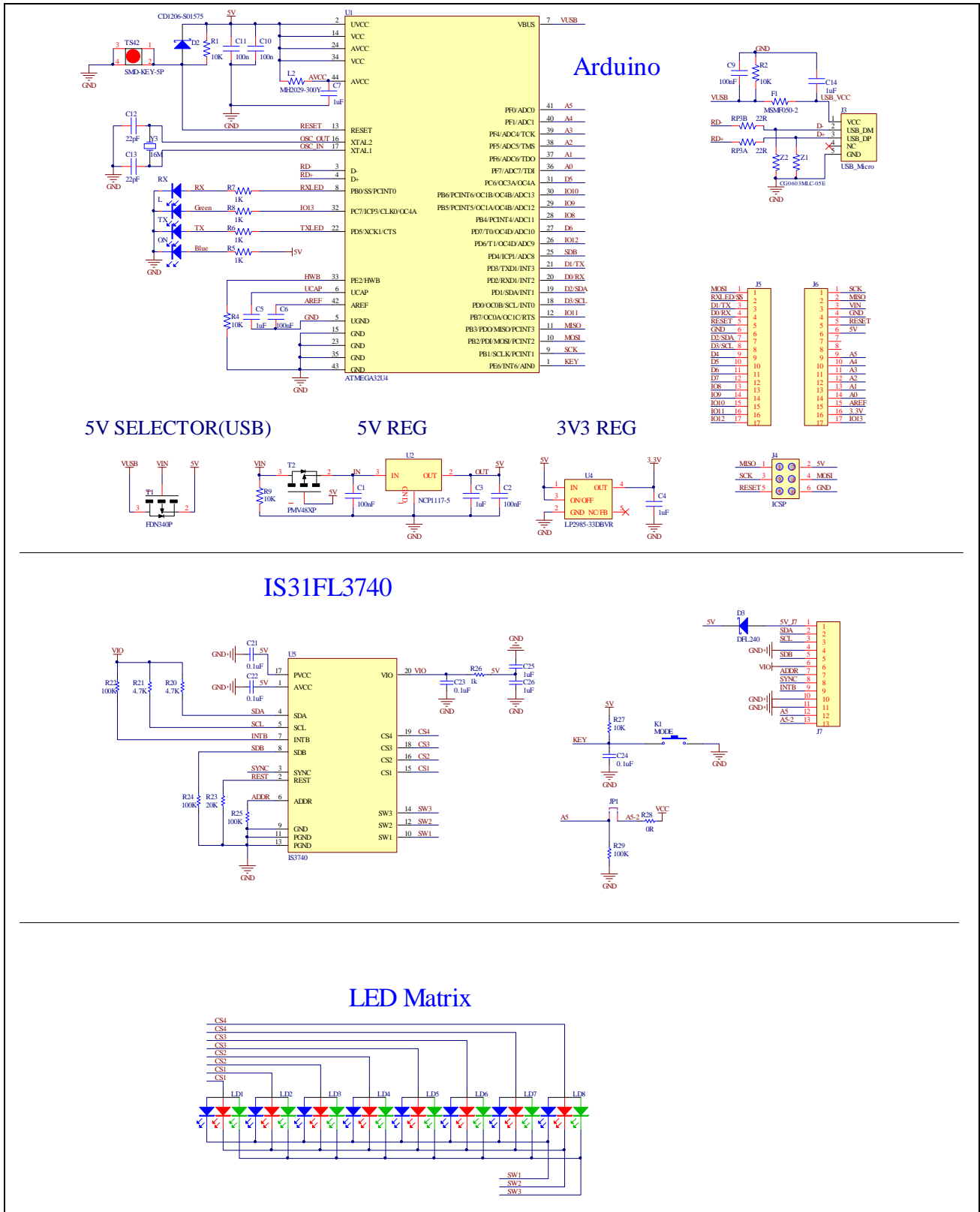

Figure 2: IS31FL3740 Application Schematic

3x4 MATRIX LED DRIVER

BILL OF MATERIALS - Arduino

Name	Symbol	Description	Qty	Supplier	Part No.
MCU	U1	Microcontroller	1	ATM	ATMEGA32U4
LDO	U2	Reduced voltage	1	ON	NCP1117-5
LDO	U4	Reduced voltage	1	TI	LP2985-33DBVR
Triode	T1	FET	1	FAIRCHILD	FDN340P
Triode	T2	FET	1	NXP	PMV48XP
Crystal	Y1	Crystal, 16MHz	1	Risym	3225 16MHz
Button	K1	Button SMD	1	MT	SMD-KEY-5P
LED	ON,TX,RX	LED, SMD Blue	3	EVERLIGHT	0603
LED	L	LED, SMD Green	1	EVERLIGHT	0603
F1	F1	SMD Fuse	1	MF	MSMF050-2
Beads	L2	Beads	1	BOURNS	MH2029-300Y
Varistor	Z1,Z2	Varistor	2	BOURNS	CG0603MLC-05E
Resistor	RP3A,PR3B	RES,22R,1/16W,±5%,SMD	2	Yageo	RC0603JR-0722RL
Resistor	R5,R6,R7,R8	RES,1k,1/16W,±5%,SMD	4	Yageo	RC0603JR-071KL
Resistor	R1,R2,R4,R9	RES,10k,1/16W,±5%,SMD	4	Yageo	RC0603JR-0710KL
Capacitor	C12,C13	CAP,22pF,16V,±20%,SMD	2	Yageo	CC0603KKX7R9BB22
Capacitor	C1,C2,C6, C9,C10,C11	CAP,100nF,16V,±20%,SMD	6	Yageo	CC0603KKX7R9BB101
Capacitor	C3,C4,C5,C7,C14	CAP,1µF,16V, ±20%,SMD	5	Yageo	CC0603KKX7R9BB105

BILL OF MATERIALS – IS31FL3740

Name	Symbol	Description	Qty	Supplier	Part No.
LED Driver	U5	Matrix LED Driver	1	ISSI	IS31FL3740
RGB LED	LD1~LD8	RGB LED, SMD	8	ROHM	SMLV56RGB1W1
Diode	D3	Diode, SMD	1	DIODES	DFLS240
Resistor	R20,R21	RES,4.7k,1/16W,±5%,SMD	2	Yageo	RC0603JR-074K7L
Resistor	R22,R24,R25,R29	RES,100k,1/16W,±5%,SMD	4	Yageo	RC0603JR-07100KL
Resistor	R23	RES,20k,1/16W,±5%,SMD	1	Yageo	RC0603JR-0720KL
Resistor	R26	RES,1k,1/16W,±5%,SMD	1	Yageo	RC0603JR-071KL
Resistor	R27	RES,10k,1/16W,±5%,SMD	1	Yageo	RC0603JR-0710KL
Resistor	R28	RES,0k,1/16W,±5%,SMD	1	Yageo	RC0603JR-070KL
Capacitor	C21,C22,C23,C24	CAP,0.1µF,16V,±20%,SMD	4	Yageo	CC0603KKX7R9BB104
Capacitor	C25,C26	CAP,1µF,16V,±20%,SMD	2	Yageo	CC0603KKX7R9BB105
Button	K1 (Bottom)	Button	1		

Bill of Materials, refer to Figure 2 above.

3x4 MATRIX LED DRIVER

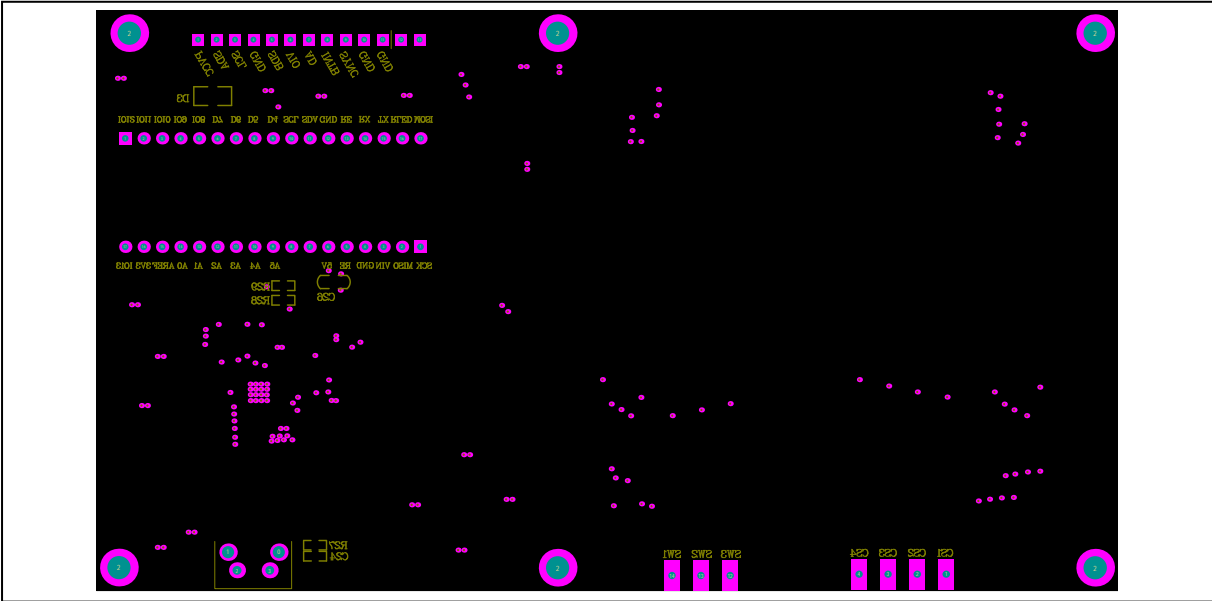

Figure 5: Board Component Placement Guide - Bottom Layer

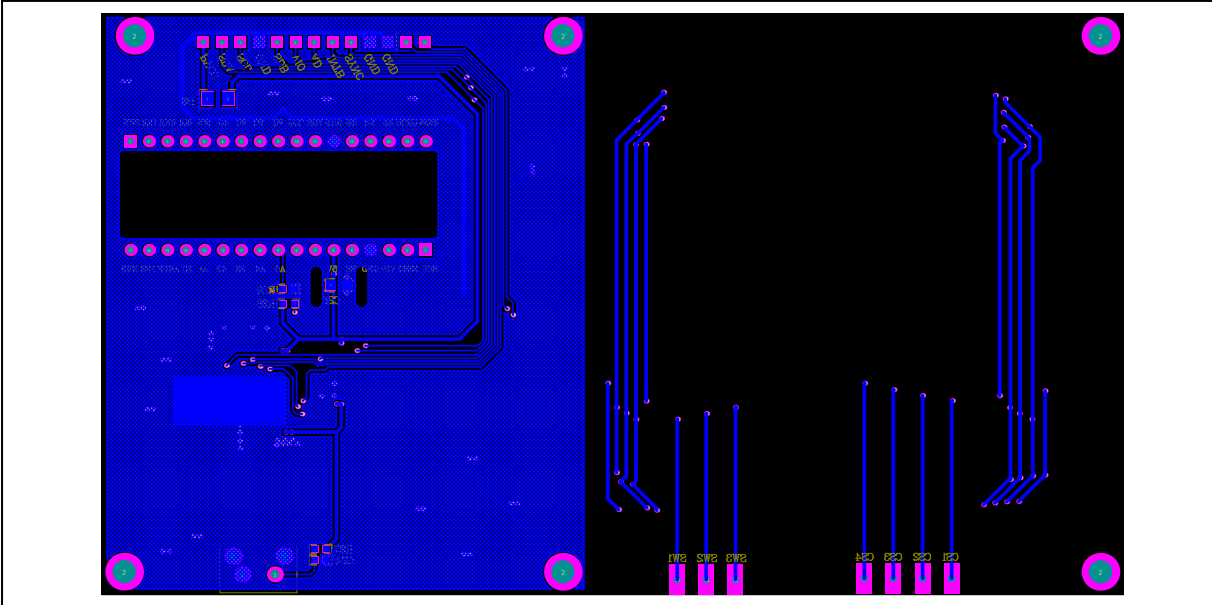

Figure 6: Board PCB Layout - Bottom Layer

3x4 MATRIX LED DRIVER

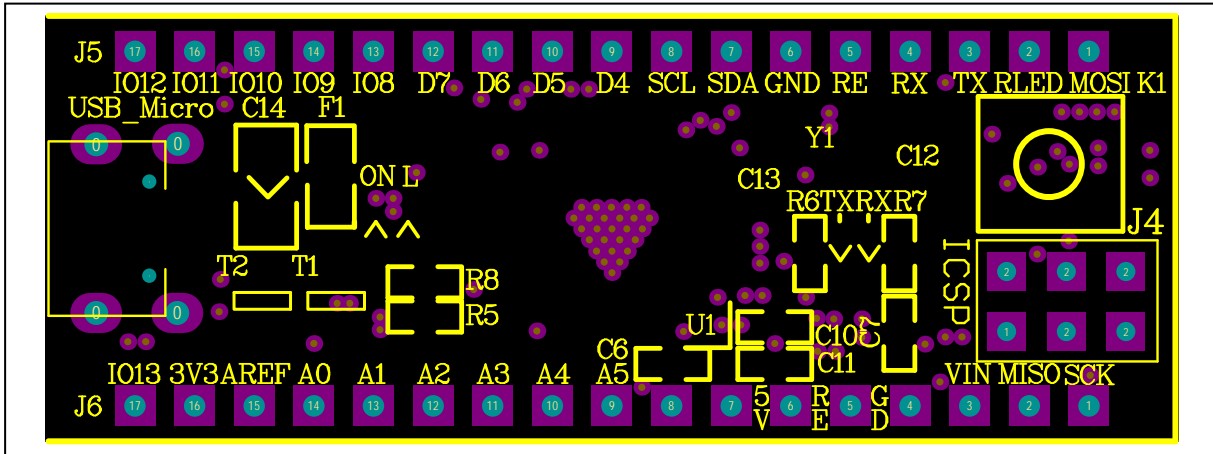

Figure 7: Arduino Board Component Placement Guide - Top Layer

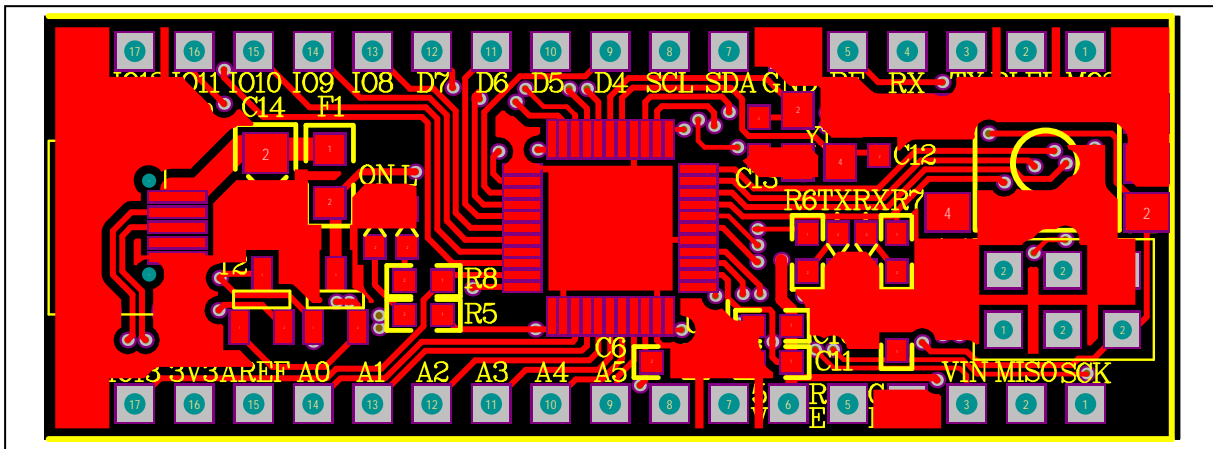

Figure 8: Arduino Board PCB Layout - Top Layer

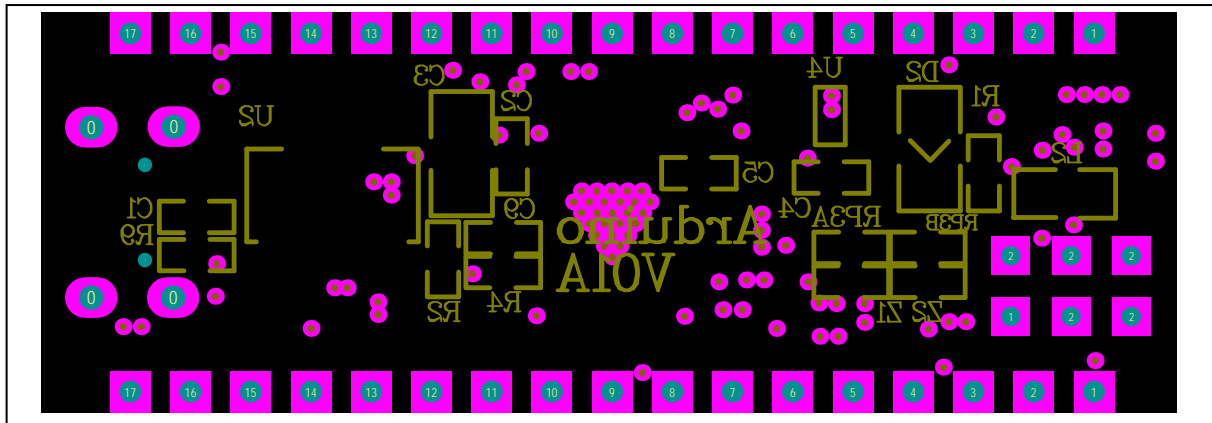

Figure 9: Arduino Board Component Placement Guide - Bottom Layer

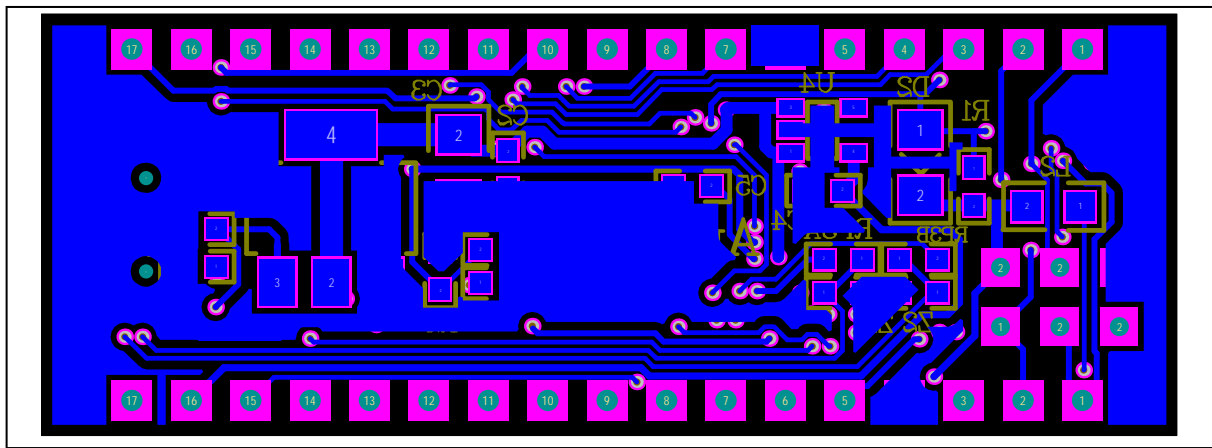

Figure 10: Arduino Board PCB Layout - Bottom Layer

Copyright © 2018 Integrated Silicon Solution, Inc. All rights reserved. ISSI reserves the right to make changes to this specification and its products at any time without notice. ISSI assumes no liability arising out of the application or use of any information, products or services described herein. Customers are advised to obtain the latest version of this device specification before relying on any published information and before placing orders for products. Integrated Silicon Solution, Inc. does not recommend the use of any of its products in life support applications where the failure or malfunction of the product can reasonably be expected to cause failure of the life support system or to significantly affect its safety or effectiveness. Products are not authorized for use in such applications unless Integrated Silicon Solution, Inc. receives written assurance to its satisfaction, that:

- the risk of injury or damage has been minimized;
- the user assume all such risks; and
- potential liability of Integrated Silicon Solution, Inc is adequately protected under the circumstances



3x4 MATRIX LED DRIVER

REVISION HISTORY

Revision	Detail Information	Date
A	Initial release	2018.01.17