

IS31FL3737

12x12 DOTS MATRIX LED DRIVER WITH INDIVIDUAL AUTO BREATH FUNCTION

December 2018

GENERAL DESCRIPTION

The IS31FL3737 is a general purpose 12x12 LEDs matrix driver with 1/12 cycle rate. The device can be programmed via an I2C compatible interface. Each LED can be dimmed individually with 8-bit PWM data which allowing 256 steps of linear dimming.

IS31FL3737 features 3 Auto Breathing Modes which are noted as ABM-1, ABM-2 and ABM-3. For each Auto Breathing Mode, there are 4 timing characters which include current rising / holding / falling / off time and 3 loop characters which include Loop-Beginning / Loop-Ending / Loop-Times. Every LED can be configured to be any Auto Breathing Mode or No-Breathing Mode individually.

Additionally each LED open and short state can be detected, IS31FL3737 store the open or short information in Open-Short Registers. The Open-Short Registers allowing MCU to read out via I2C compatible interface. Inform MCU whether there are LEDs open or short and the locations of open or short LEDs.

The IS31FL3737 operates from 2.7V to 5.5V and features a very low shutdown and operational current.

IS31FL3737 is available in QFN-40 (5mmx5mm) package. It operates from 2.7V to 5.5V over the temperature range of -40°C to +125°C.

FEATURES

- Supply voltage range: 2.7V to 5.5V
- 12 current source outputs for row control
- 12 switch current inputs for column scan control
- Up to 144 LEDs (12x12) in dot matrix
- Programmable 12x12 (48 RGBs) matrix size with de-ghost function
- 1MHz I2C-compatible interface
- Selectable 3 Auto Breath Modes for each dot
- Auto Breath Loop Features interrupt pin inform MCU Auto Breath Loop completed
- Auto Breath offers 128 steps gamma current, interrupt and state look up registers
- 256 steps Global Current Setting
- Individual on/off control
- Individual 256 PWM control steps
- Individual Auto Breath Mode select
- Individual open and short error detect function
- Cascade for synchronization of chips
- QFN-40 (5mmx5mm) package

APPLICATIONS

- Hand-held devices for LED display
- Gaming device (Keyboard, Mouse etc.)
- LED in white goods application

TYPICAL APPLICATION CIRCUIT

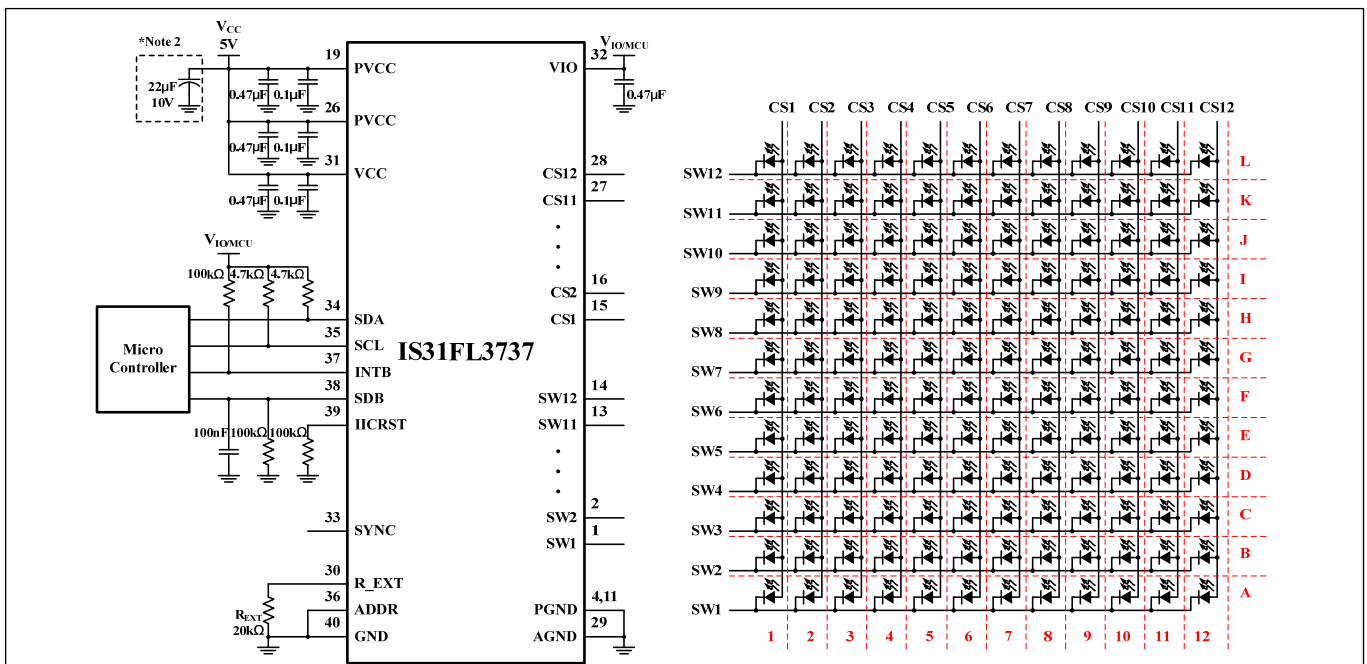

Figure 1 Typical Application Circuit (12x12)

IS31FL3737

TYPICAL APPLICATION CIRCUIT (CONTINUED)

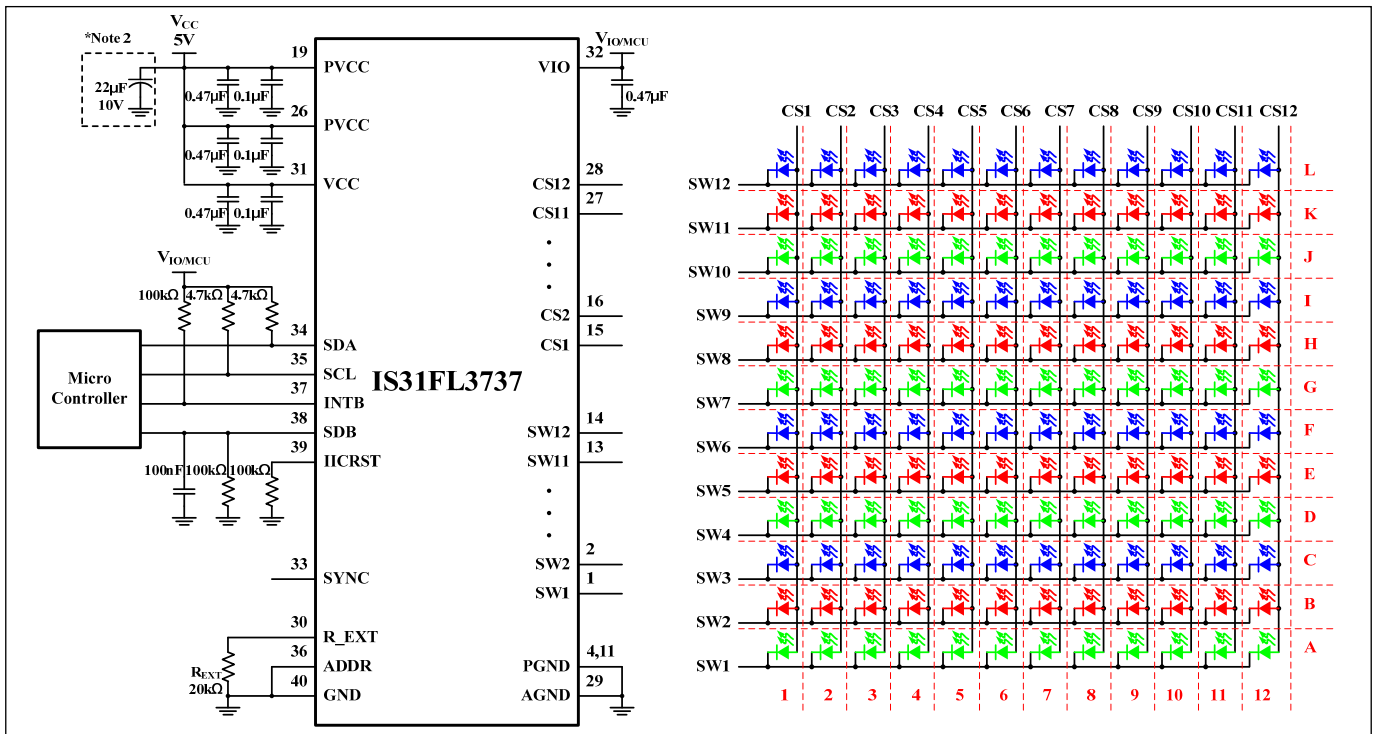

Figure 2 Typical Application Circuit (RGB)

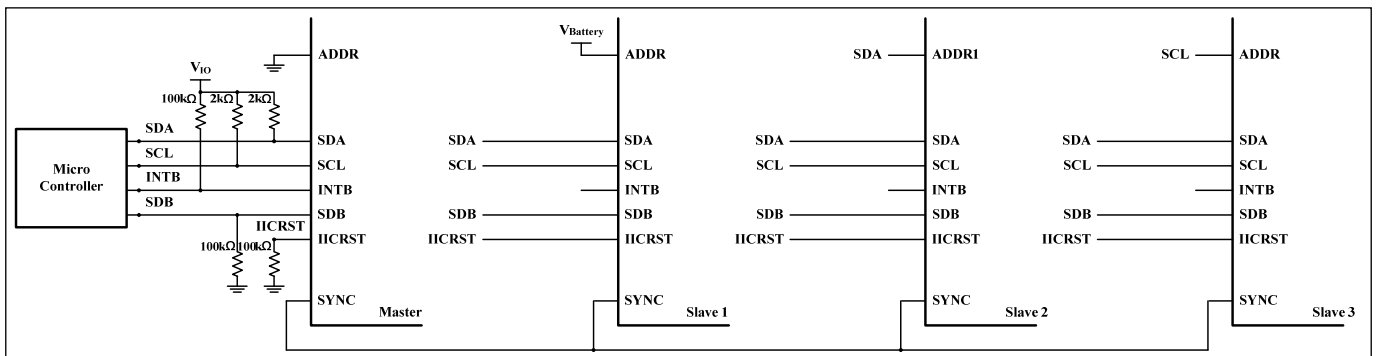

Figure 3 Typical Application Circuit (Four Parts Synchronization-Work)

Note 1: IC should be placed far away from the antenna in order to prevent the EMI.

Note 2: Electrolytic/Tantalum Capacitor may be considered for high current application to avoid audible noise interference.

Note 3: The VIO should be $1.8V \leq V_{IO} \leq V_{CC}$. And it is recommended to be equal to V_{OH} of the micro controller. For example, if $V_{OH}=1.8V$, set $V_{IO}=1.8V$, if $V_{OH}=3.3V$, set $V_{IO}=3.3V$.

Note 4: One system should contain only one master, all slave parts should be configured as slave mode before the master is configured as master mode. Work as master mode or slave mode specified by Configuration Register (Function register, address 00h). Master part output master clock, and all the other parts which work as slave input this master clock.

IS31FL3737

PIN CONFIGURATION

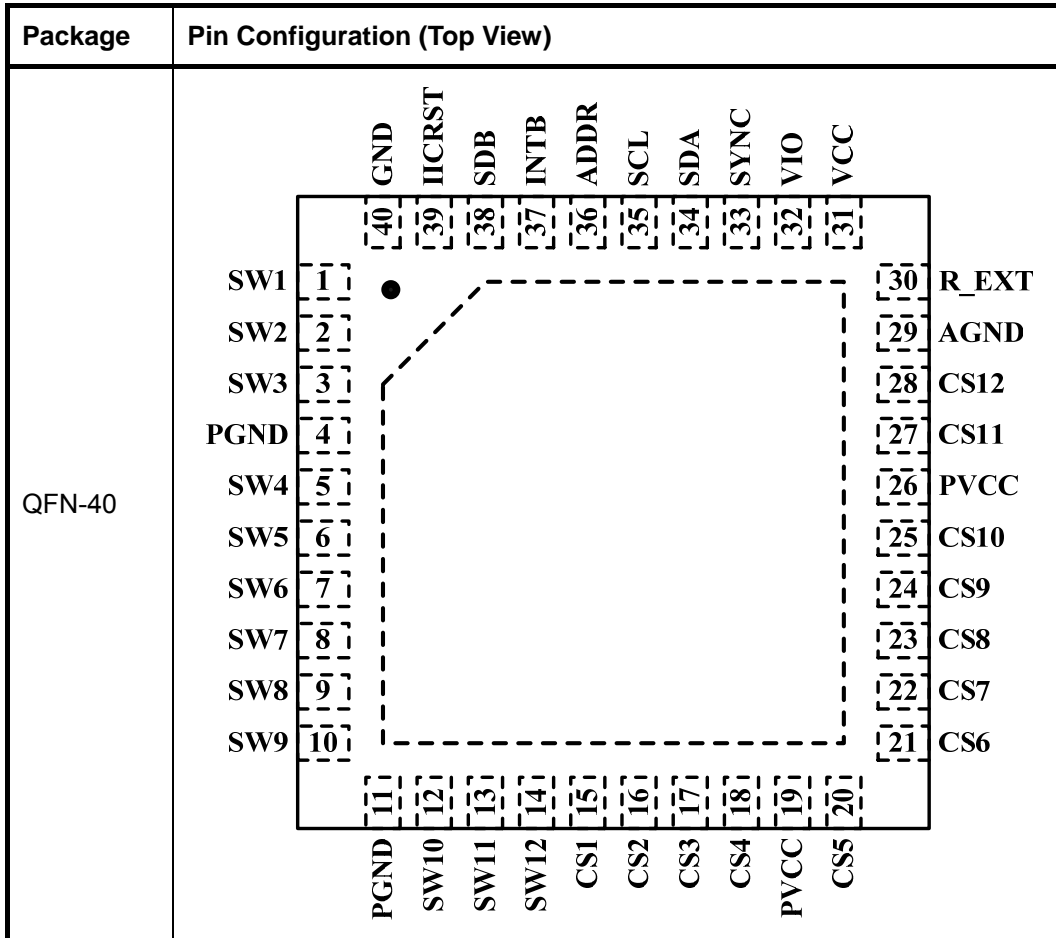

IS31FL3737

PIN DESCRIPTION

No.	Pin	Description
1~3,5~10, 12~14	SW1~SW12	Switch pin for LED matrix scanning.
4,11	PGND	Power GND.
15~18,20~25, 27,28	CS1~CS12	Current Source.
19,26	PVCC	Power for current source.
29	AGND	Analog GND.
30	R_EXT	Input terminal used to connect an external resistor. This regulates current source DC current value.
31	VCC	Power for analog and digital circuits.
32	VIO	Input logic reference voltage.
33	SYNC	Synchronize pin. It is used for more than one part work synchronize. If it is not used please float this pin.
34	SDA	I2C compatible serial data.
35	SCL	I2C compatible serial clock.
36	ADDR	I2C address setting.
37	INTB	Interrupt output pin. Register F0h sets the function of the INTB pin and active low when the interrupt event happens. Can be NC (float) if interrupt function no used.
38	SDB	Shutdown the chip when pull to low.
39	IICRST	Reset I2C when pull high, need to pull down when normal operation.
40	GND	Connect to GND.
	Thermal Pad	Need to connect to GND pins.



IS31FL3737

ORDERING INFORMATION

Industrial Range: -40°C to +125°C

Order Part No.	Package	QTY/Reel
IS31FL3737-QFLS4-TR	QFN-40, Lead-free	2500

Copyright © 2018 Integrated Silicon Solution, Inc. All rights reserved. ISSI reserves the right to make changes to this specification and its products at any time without notice. ISSI assumes no liability arising out of the application or use of any information, products or services described herein. Customers are advised to obtain the latest version of this device specification before relying on any published information and before placing orders for products.

Integrated Silicon Solution, Inc. does not recommend the use of any of its products in life support applications where the failure or malfunction of the product can reasonably be expected to cause failure of the life support system or to significantly affect its safety or effectiveness.

Products are not authorized for use in such applications unless Integrated Silicon Solution, Inc. receives written assurance to its satisfaction, that:

- a.) the risk of injury or damage has been minimized;
- b.) the user assume all such risks; and
- c.) potential liability of Integrated Silicon Solution, Inc is adequately protected under the circumstances

IS31FL3737

ABSOLUTE MAXIMUM RATINGS

Supply voltage, V_{CC}	-0.3V ~ +6.0V
Voltage at any input pin	-0.3V ~ $V_{CC}+0.3V$
Maximum junction temperature, T_{JMAX}	150°C
Storage temperature range, T_{STG}	-65°C ~ +150°C
Operating temperature range, $T_A = T_J$	-40°C ~ +125°C
Package thermal resistance, junction to ambient (4 layer standard test PCB based on JESD 51-2A standard), θ_{JA}	31°C/W
ESD (HBM)	±8kV
ESD (CDM)	±1kV

Note 5: Stresses beyond those listed under “Absolute Maximum Ratings” may cause permanent damage to the device. These are stress ratings only and functional operation of the device at these or any other condition beyond those indicated in the operational sections of the specifications is not implied. Exposure to absolute maximum rating conditions for extended periods may affect device reliability.

ELECTRICAL CHARACTERISTICS

The following specifications apply for $V_{CC} = 3.6V$, $T_A = 25^\circ C$, unless otherwise noted.

Symbol	Parameter	Conditions	Min.	Typ.	Max.	Unit
V_{CC}	Supply voltage		2.7		5.5	V
I_{CC}	Quiescent power supply current	$V_{SDB} = V_{CC}$, all LEDs off		2	3	mA
I_{SD}	Shutdown current	$V_{SDB} = 0V$		2	5	μA
		$V_{SDB} = V_{CC}$, Configuration Register written “0000 0000”		2	5	
I_{OUT}	Maximum constant current of CS1~CS12	$R_{EXT} = 20k\Omega$	39	42	45	mA
I_{LED}	Average current on each LED $I_{LED} = I_{OUT}/12.75$	$R_{EXT} = 20k\Omega$, GCC= 255, PWM= 255	3.06	3.29	3.53	mA
V_{HR}	Current sink headroom voltage SW1~SW12	$I_{SINK} = 504mA$ (Note 6, 7)		250	350	mV
	Current source headroom voltage CS1~C12	$I_{SOURCE} = 42mA$ (Note 6)		150	200	
t_{SCAN}	Period of scanning		115	128	140	μs
t_{NOL}	Non-overlap blanking time during scan, the SWy and CSx are all off during this time		7.2	8	8.75	μs

Logic Electrical Characteristics (SDA, SCL, ADDR1, ADDR2, SYNC, SDB)

V_{IL}	Logic “0” input voltage	$V_{IO} = 3.6V$	GND		$0.2V_{IO}$	V
V_{IH}	Logic “1” input voltage	$V_{IO} = 3.6V$	$0.75V_{IO}$		V_{IO}	V
V_{HYS}	Input schmitt trigger hysteresis	$V_{IO} = 3.6V$		0.2		V
V_{OL}	Logic “0” output voltage for SYNC	$I_{OL} = 8mA$			0.4	V
V_{OH}	Logic “1” output voltage for SYNC	$I_{OH} = 8mA$	$0.75V_{IO}$			V
I_{IL}	Logic “0” input current	$V_{INPUT} = 0V$ (Note 8)		5		nA
I_{IH}	Logic “1” input current	$V_{INPUT} = V_{IO}$ (Note 8)		5		nA

IS31FL3737

DIGITAL INPUT SWITCHING CHARACTERISTICS (NOTE 8)

Symbol	Parameter	Fast Mode			Fast Mode Plus			Units
		Min.	Typ.	Max.	Min.	Typ.	Max.	
f_{SCL}	Serial-clock frequency	-		400	-		1000	kHz
t_{BUF}	Bus free time between a STOP and a START condition	1.3		-	0.5		-	μ s
$t_{HD, STA}$	Hold time (repeated) START condition	0.6		-	0.26		-	μ s
$t_{SU, STA}$	Repeated START condition setup time	0.6		-	0.26		-	μ s
$t_{SU, STO}$	STOP condition setup time	0.6		-	0.26		-	μ s
$t_{HD, DAT}$	Data hold time	-		-	-		-	μ s
$t_{SU, DAT}$	Data setup time	100		-	50		-	ns
t_{LOW}	SCL clock low period	1.3		-	0.5		-	μ s
t_{HIGH}	SCL clock high period	0.7		-	0.26		-	μ s
t_R	Rise time of both SDA and SCL signals, receiving	-		300	-		120	ns
t_F	Fall time of both SDA and SCL signals, receiving	-		300	-		120	ns

Note 6: In case of $R_{EXT} = 20k\Omega$, Global Current Control Register (PG3, 01h) written "1111 1111", GCC = "1111 1111".

Note 7: All LEDs are on and PWM = "1111 1111", GCC = "1111 1111".

Note 8: Guaranteed by design.

IS31FL3737

FUNCTIONAL BLOCK DIAGRAM

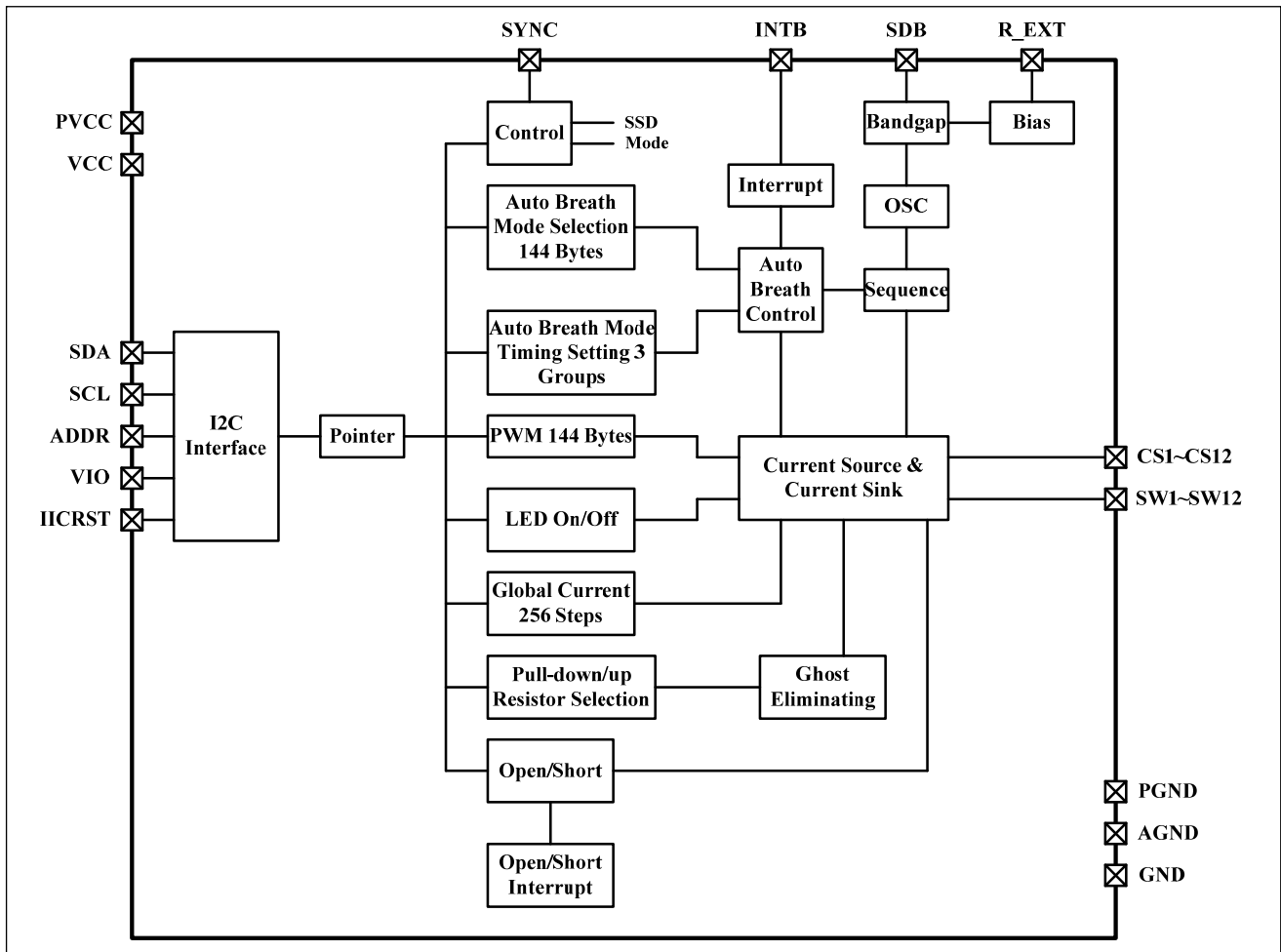

IS31FL3737

DETAILED DESCRIPTION

I2C INTERFACE

The IS31FL3737 uses a serial bus, which conforms to the I2C protocol, to control the chip's functions with two wires: SCL and SDA. The IS31FL3737 has a 7-bit slave address (A7:A1), followed by the R/W bit, A0. Set A0 to "0" for a write command and set A0 to "1" for a read command. The value of bits A4:A1 are decided by the connection of the ADDR pin.

The complete slave address is:

Table 1 Slave Address:

ADDR	A7:A5	A4:A1	A0
GND	101	0000	0/1
SCL		0101	
SDA		1010	
VCC		1111	

ADDR connected to GND, (A4:A1)= 0000;

ADDR connected to VCC, (A4:A1)= 1111;

ADDR connected to SCL, (A4:A1)= 0101;

ADDR connected to SDA, (A4:A1)= 1010;

The SCL line is uni-directional. The SDA line is bi-directional (open-collector) with a pull-up resistor (typically 2kΩ). The maximum clock frequency specified by the I2C standard is 1MHz. In this discussion, the master is the microcontroller and the slave is the IS31FL3737.

The timing diagram for the I2C is shown in Figure 4. The SDA is latched in on the stable high level of the SCL. When there is no interface activity, the SDA line should be held high.

The "START" signal is generated by lowering the SDA signal while the SCL signal is high. The start signal will alert all devices attached to the I2C bus to check the incoming address against their own chip address.

The 8-bit chip address is sent next, most significant bit first. Each address bit must be stable while the SCL level is high.

After the last bit of the chip address is sent, the master checks for the IS31FL3737's acknowledge. The master releases the SDA line high (through a pull-up resistor). Then the master sends an SCL pulse. If the

IS31FL3737 has received the address correctly, then it holds the SDA line low during the SCL pulse. If the SDA line is not low, then the master should send a "STOP" signal (discussed later) and abort the transfer.

Following acknowledge of IS31FL3737, the register address byte is sent, most significant bit first. IS31FL3737 must generate another acknowledge indicating that the register address has been received.

Then 8-bit of data byte are sent next, most significant bit first. Each data bit should be valid while the SCL level is stable high. After the data byte is sent, the IS31FL3737 must generate another acknowledge to indicate that the data was received.

The "STOP" signal ends the transfer. To signal "STOP", the SDA signal goes high while the SCL signal is high.

ADDRESS AUTO INCREMENT

To write multiple bytes of data into IS31FL3737, load the address of the data register that the first data byte is intended for. During the IS31FL3737 acknowledge of receiving the data byte, the internal address pointer will increment by one. The next data byte sent to IS31FL3737 will be placed in the new address, and so on. The auto increment of the address will continue as long as data continues to be written to IS31FL3737 (Figure 7).

READING OPERATION

FEh, F1h and 18h~47h of Page 0 can be read.

To read the FEh and F1h, after I2C start condition, the bus master must send the IS31FL3737 device address with the R/W bit set to "0", followed by the register address (FEh or F1h) which determines which register is accessed. Then restart I2C, the bus master should send the IS31FL3737 device address with the R/W bit set to "1". Data from the register defined by the command byte is then sent from the IS31FL3737 to the master (Figure 8).

To read the 18h~47h of Page 0, the FDh should write with 00h before follow the Figure 8 sequence to read the data, that means, when you want to read 18h~47h of Page 0, the FDh should point to Page 0 first and you can read the Page 0 data.

IS31FL3737

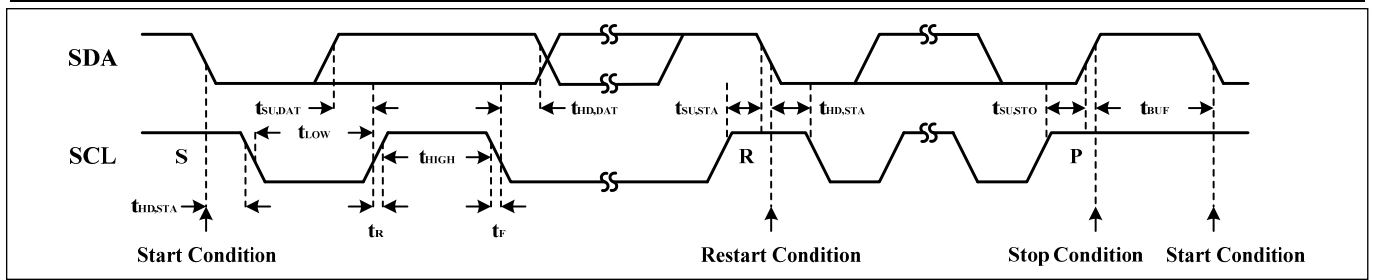

Figure 4 Interface Timing

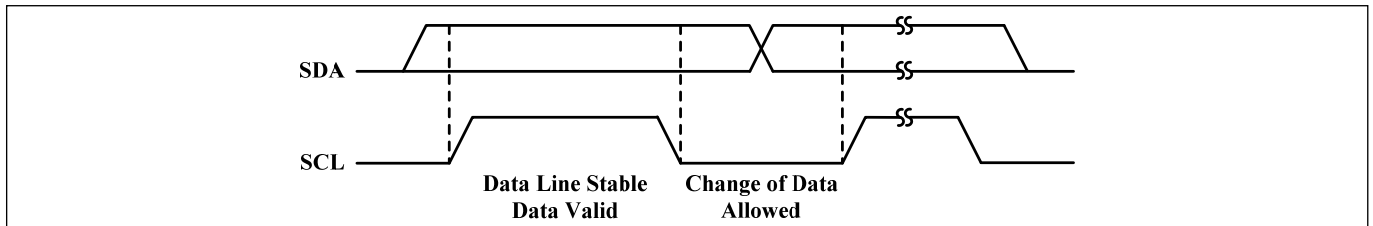

Figure 5 Bit Transfer

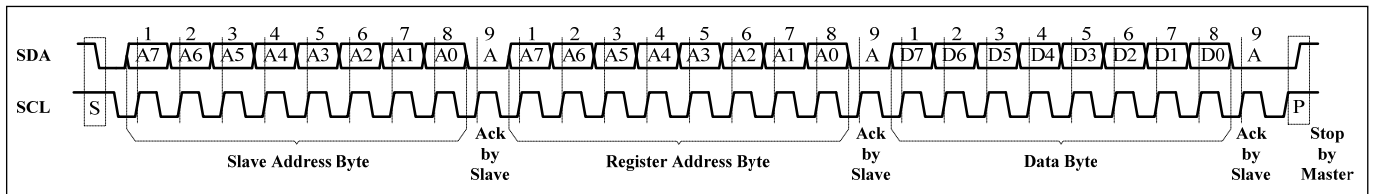

Figure 6 Writing to IS31FL3737 (Typical)

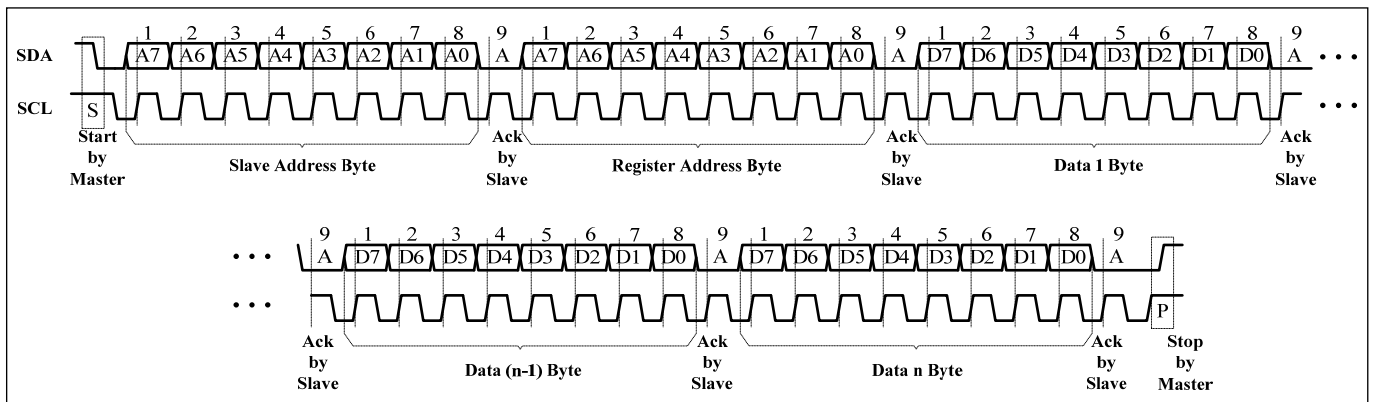

Figure 7 Writing to IS31FL3737 (Automatic address increment)

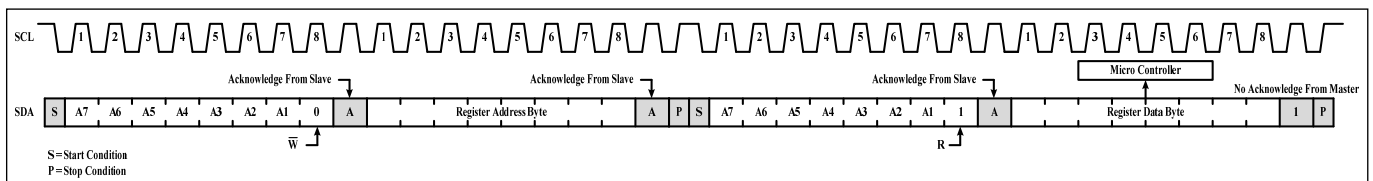

Figure 8 Reading from IS31FL3737

IS31FL3737

REGISTER DEFINITION-1

Address	Name	Function	Table	R/W	Default
FDh	Command Register	Available Page 0 to Page 3 Registers	2	W	xxxx xxxx
FEh	Command Register Write Lock	To lock/unlock Command Register	3	R/W	0000 0000
F0h	Interrupt Mask Register	Configure the interrupt function	4	W	
F1h	Interrupt Status Register	Show the interrupt status	5	R	

REGISTER CONTROL

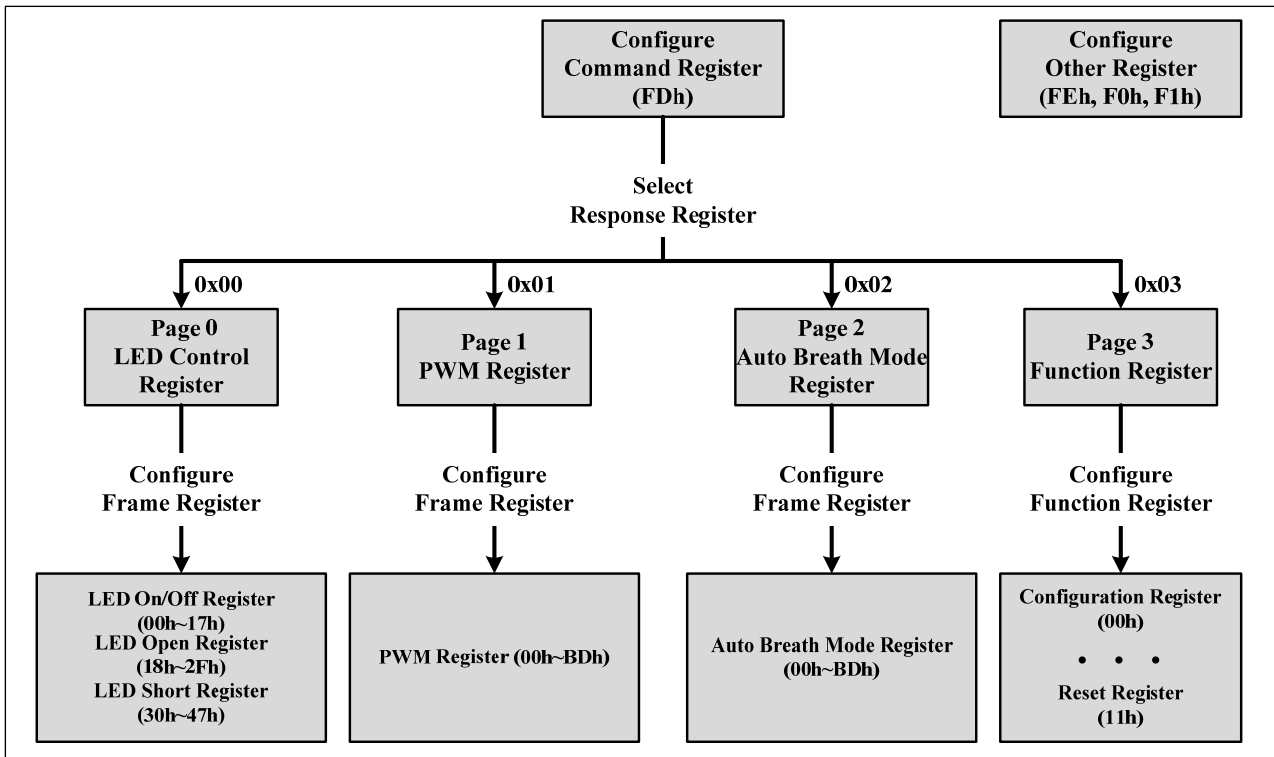

Table 2 FDh Command Register (Write Only)

Data	Function
0000 0000	Point to Page 0 (PG0, LED Control Register is available)
0000 0001	Point to Page 1 (PG1, PWM Register is available)
0000 0010	Point to Page 2 (PG2, Auto Breath Mode Register is available)
0000 0011	Point to Page 3 (PG3, Function Register is available)
Others	Reserved

Note: FDh is locked when power up, need to unlock this register before write command to it. See Table 3 for detail.

The Command Register should be configured first after writing in the slave address to choose the available register. Then write data in the choosing register. Power up default state is "0000 0000".

For example, when write "0000 0001" in the Command Register (FDh), the data which writing after will be stored in the PWM Register (Page1). Write new data can configure other registers.

IS31FL3737

Table 3 FEh Command Register Write Lock (Read/Write)

Bit	D7:D0
Name	CRWL
Default	0000 0000 (FDh write disable)

To select the PG0~PG3, need to unlock this register first, with the purpose to avoid misoperation of this register. When FEh is written with 0xC5, FDh is allowed to modify once, after the FDh is modified the FEh will reset to be 0x00 at once.

CRWL Command Register Write Lock
 0x00 FDh write disable
 0xC5 FDh write enable once

Table 4 F0h Interrupt Mask Register (Write Only)

Bit	D7:D4	D3	D2	D1	D0
Name	-	IAC	IAB	IS	IO
Default	0000	0	0	0	0

Configure the interrupt function for IC.

IAC Auto Clear Interrupt Bit
 0 Interrupt could not auto clear
 1 Interrupt auto clear when INTB stay low exceeds 8ms

IAB Auto Breath Interrupt Bit
 0 Disable auto breath loop finish interrupt
 1 Enable auto breath loop finish interrupt

IS Dot Short Interrupt Bit
 0 Disable dot short interrupt
 1 Enable dot short interrupt

IO Dot Open Interrupt Bit
 0 Disable dot open interrupt
 1 Enable dot open interrupt

Table 5 F1h Interrupt Status Register (Read Only)

Bit	D7:D5	D4	D3	D2	D1	D0
Name	-	ABM3	ABM2	ABM1	SB	OB
Default	000	0	0	0	0	0

Show the interrupt status for IC.

ABM3 Auto Breath Mode 3 Finish Bit
 0 ABM3 not finish
 1 ABM3 finish

ABM2 Auto Breath Mode 2 Finish Bit
 0 ABM2 not finish
 1 ABM2 finish

ABM1 Auto Breath Mode 1 Finish Bit
 0 ABM1 not finish
 1 ABM1 finish

SB Short Bit
 0 No short
 1 Short happens

OB Open Bit
 0 No open
 1 Open happens

IS31FL3737

REGISTER DEFINITION-2

Address	Name	Function	Table	R/W	Default
PG0 (0x00): LED Control Register					
00h ~ 17h	LED On/Off Register	Set on or off state for each LED	7	W	0000 0000
18h ~ 2Fh	LED Open Register	Store open state for each LED	8	R	
30h ~ 47h	LED Short Register	Store short state for each LED	9	R	
PG1 (0x01): PWM Register					
00h~BDh	PWM Register	Set PWM duty for LED	10	W	0000 0000
PG2 (0x02): Auto Breath Mode Register					
00h~BDh	Auto Breath Mode Register	Set operating mode of each dot	11	W	xxxx xx00
PG3 (0x03) : Function Register					
00h	Configuration Register	Configure the operation mode	13	W	0000 0000
01h	Global Current Control Register	Set the global current	14	W	
02h	Auto Breath Control Register 1 of ABM-1	Set fade in and hold time for breath function of ABM-1	15	W	
03h	Auto Breath Control Register 2 of ABM-1	Set the fade out and off time for breath function of ABM-1	16	W	
04h	Auto Breath Control Register 3 of ABM-1	Set loop characters of ABM-1	17	W	
05h	Auto Breath Control Register 4 of ABM-1	Set loop characters of ABM-1	18	W	
06h	Auto Breath Control Register 1 of ABM-2	Set fade in and hold time for breath function of ABM-2	15	W	
07h	Auto Breath Control Register 2 of ABM-2	Set the fade out and off time for breath function of ABM-2	16	W	
08h	Auto Breath Control Register 3 of ABM-2	Set loop characters of ABM-2	17	W	
09h	Auto Breath Control Register 4 of ABM-2	Set loop characters of ABM-2	18	W	
0Ah	Auto Breath Control Register 1 of ABM-3	Set fade in and hold time for breath function of ABM-3	15	W	
0Bh	Auto Breath Control Register 2 of ABM-3	Set the fade out and off time for breath function of ABM-3	16	W	
0Ch	Auto Breath Control Register 3 of ABM-3	Set loop characters of ABM-3	17	W	
0Dh	Auto Breath Control Register 4 of ABM-3	Set loop characters of ABM-3	18	W	
0Eh	Time Update Register	Update the setting of 02h ~ 0Dh registers	-	W	
0Fh	SWy Pull-Up Resistor Selection Register	Set the pull-up resistor for SWy	19	W	
10h	CSx Pull-Down Resistor Selection Register	Set the pull-down resistor for CSx	20	W	
11h	Reset Register	Reset all register to POR state	-	R	

IS31FL3737

Table 6 Page 0 (PG0, 0x00): LED Control Register

LED Location		LED On/Off Register		LED Open Register		LED Short Register	
SW1(CS1~ CS6)	SW1(CS7~ CS12)	00h	01h	18h	19h	30h	31h
SW2(CS1~ CS6)	SW2(CS7~ CS12)	02h	03h	1Ah	1Bh	32h	33h
SW3(CS1~ CS6)	SW3(CS7~ CS12)	04h	05h	1Ch	1Dh	34h	35h
SW4(CS1~ CS6)	SW4(CS7~ CS12)	06h	07h	1Eh	1Fh	36h	37h
SW5(CS1~ CS6)	SW5(CS7~ CS12)	08h	09h	20h	21h	38h	39h
SW6(CS1~ CS6)	SW6(CS7~ CS12)	0Ah	0Bh	22h	23h	3Ah	3Bh
SW7(CS1~ CS6)	SW7(CS7~ CS12)	0Ch	0Dh	24h	25h	3Ch	3Dh
SW8(CS1~ CS6)	SW8(CS7~ CS12)	0Eh	0Fh	26h	27h	3Eh	3Fh
SW9(CS1~ CS6)	SW9(CS7~ CS12)	10h	11h	28h	29h	40h	41h
SW10(CS1~ CS6)	SW10(CS7~ CS12)	12h	13h	2Ah	2Bh	42h	43h
SW11(CS1~ CS6)	SW11(CS7~ CS12)	14h	15h	2Ch	2Dh	44h	45h
SW12(CS1~ CS6)	SW12(CS7~ CS12)	16h	17h	2Eh	2Fh	46h	47h

Table 7 00h ~ 17h LED On/Off Register

Bit	D7:D6	D5:D0
Name	-	C _{CS6} : C _{CS1} or C _{CS12} : C _{CS7}
Default	00	00 0000

The LED On/Off Registers store the on or off state of each LED in the Matrix.

C_{x-y} LED State Bit
 0 LED off
 1 LED on

Table 9 30h ~ 47h LED Short Register

Bit	D7:D6	D5:D0
Name	-	ST ₆ : ST ₁ or ST ₁₂ : ST ₇
Default	00	0000 0000

The LED Short Registers store the short or normal state of each LED in the Matrix.

ST_x LED Short Bit
 0 LED normal
 1 LED short

Table 8 18h ~ 2Fh LED Open Register

Bit	D7:D6	D5:D0
Name	-	OP ₆ : OP ₁ or OP ₁₂ : OP ₇
Default	00	00 0000

The LED Open Registers store the open or normal state of each LED in the Matrix.

OP_x LED Open Bit
 0 LED normal
 1 LED open

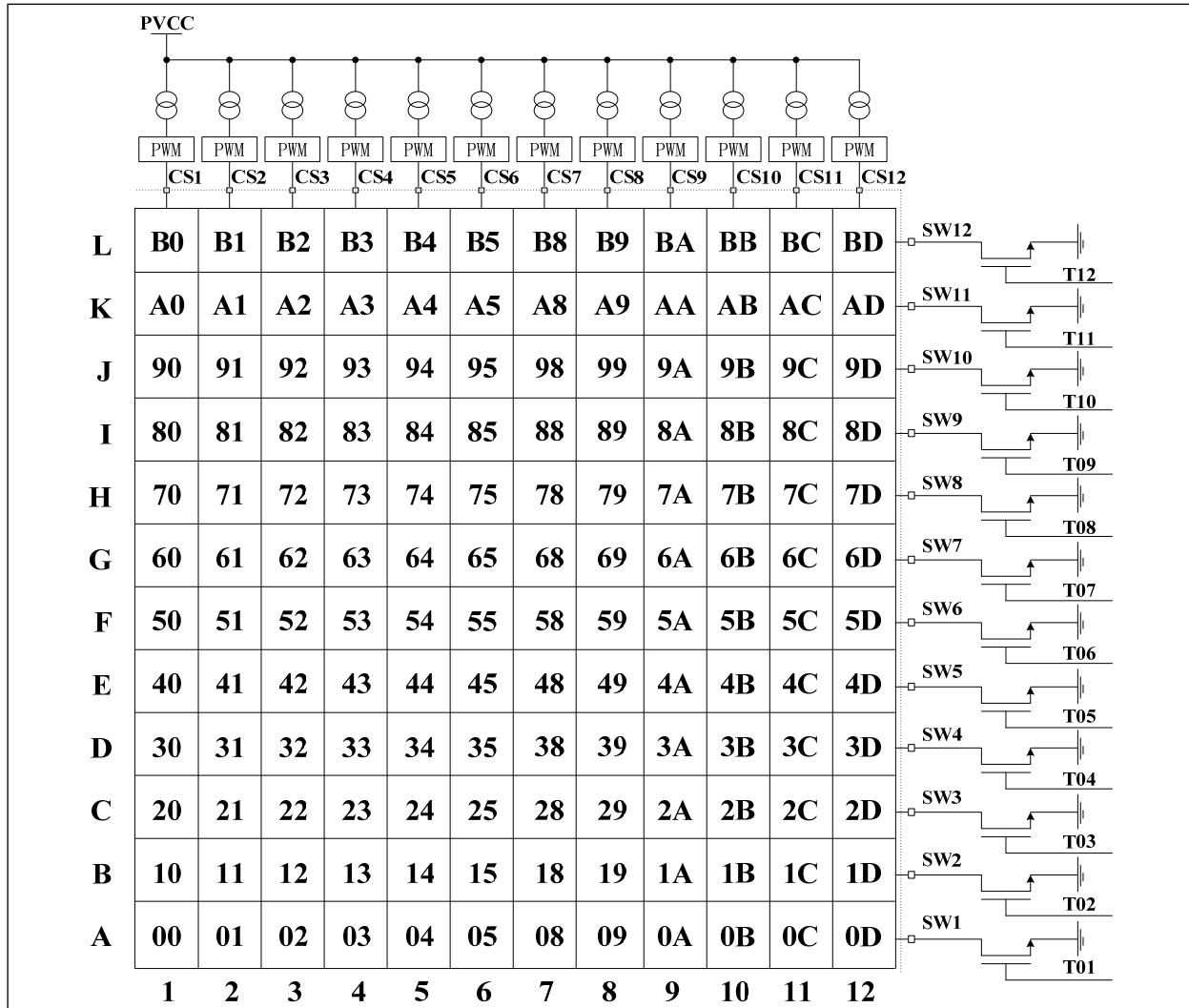

Figure 9 PWM Register

Table 10 00h ~ BDh PWM Register

Bit	D7:D0
Name	PWM
Default	0000 0000

Each dot has a byte to modulate the PWM duty in 256 steps.

The value of the PWM Registers decides the average current of each LED noted I_{LED} .

I_{LED} computed by Formula (1):

$$I_{LED} = \frac{PWM}{256} \times I_{OUT} \times Duty \quad (1)$$

$$PWM = \sum_{n=0}^7 D[n] \cdot 2^n$$

Where Duty is the duty cycle of SWy,

$$Duty = \frac{128\mu s}{(128\mu s + 8\mu s)} \times \frac{1}{12} = \frac{1}{12.75} \quad (2)$$

I_{OUT} is the output current of CSx (x=1~12),

$$I_{OUT} = \frac{840}{R_{EXT}} \times \frac{GCC}{256} \quad (3)$$

GCC is the Global Current Control register (PG3, 01h) value and R_{EXT} is the external resistor of R_{EXT} pin. D[n] stands for the individual bit value, 1 or 0, in location n.

For example: if D7:D0 = 1011 0101 (0xB5, 181), GCC=255, R_{EXT} =20k Ω (I_{OUT} =42mA),

$$I_{LED} = \frac{2^0 + 2^2 + 2^4 + 2^5 + 2^7}{256} \times I_{OUT} \times \frac{1}{12.75} = 2.34mA$$

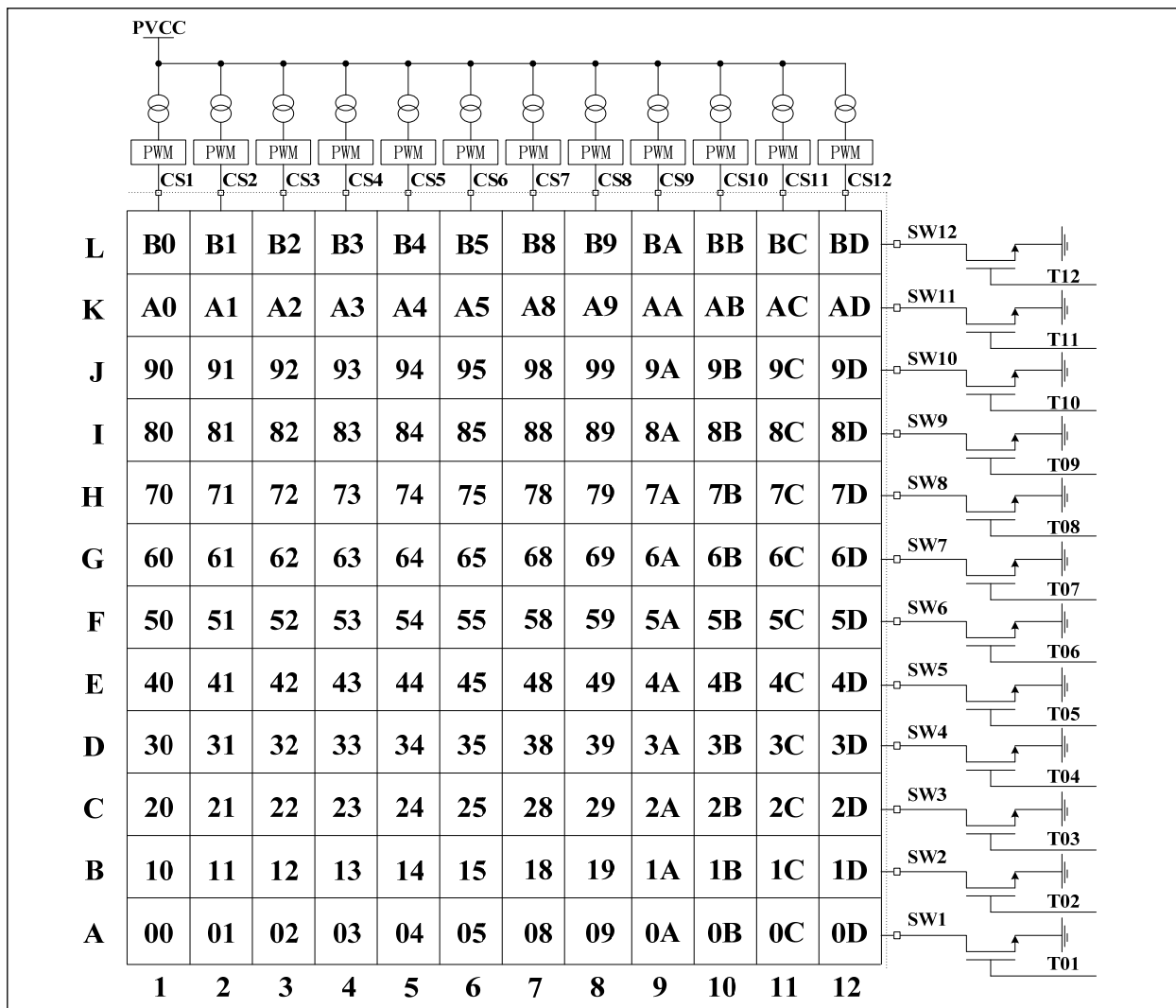

Figure 10 Auto Breath Mode Selection Register

Table 11 00h ~ BDh Auto Breath Mode Register

Bit	D7:D2	D1:D0
Name	-	ABMS
Default	-	00

The Auto Breath Mode Register sets operating mode of each dot.

ABMS Auto Breath Mode Selection Bit

- 00 PWM control mode
- 01 Select Auto Breath Mode 1 (ABM-1)
- 10 Select Auto Breath Mode 2 (ABM-2)
- 11 Select Auto Breath Mode 3 (ABM-3)

IS31FL3737

Table 12 Page 3 (PG3, 0x03): Function Register

Register	Name	Function	R/W	Default
00h	Configuration Register	Configure the operation mode	W	0000 0000
01h	Global Current Control Register	Set the global current	W	
02h	Auto Breath Control Register 1 of ABM-1	Set fade in and hold time for breath function of ABM-1	W	
03h	Auto Breath Control Register 2 of ABM-1	Set the fade out and off time for breath function of ABM-1	W	
04h	Auto Breath Control Register 3 of ABM-1	Set loop characters of ABM-1	W	
05h	Auto Breath Control Register 4 of ABM-1	Set loop characters of ABM-1	W	
06h	Auto Breath Control Register 1 of ABM-2	Set fade in and hold time for breath function of ABM-2	W	
07h	Auto Breath Control Register 2 of ABM-2	Set the fade out and off time for breath function of ABM-2	W	
08h	Auto Breath Control Register 3 of ABM-2	Set loop characters of ABM-2	W	
09h	Auto Breath Control Register 4 of ABM-2	Set loop characters of ABM-2	W	
0Ah	Auto Breath Control Register 1 of ABM-3	Set fade in and hold time for breath function of ABM-3	W	
0Bh	Auto Breath Control Register 2 of ABM-3	Set the fade out and off time for breath function of ABM-3	W	
0Ch	Auto Breath Control Register 3 of ABM-3	Set loop characters of ABM-3	W	
0Dh	Auto Breath Control Register 4 of ABM-3	Set loop characters of ABM-3	W	
0Eh	Time Update Register	Update the setting of 02h ~ 0Dh registers	W	
0Fh	SWy Pull-Up Resistor Selection Register	Set the pull-up resistor for SWy	W	
10h	CSx Pull-Down Resistor Selection Register	Set the pull-down resistor for CSx	W	
11h	Reset Register	Reset all register to POR state	R	

Table 13 00h Configuration Register

Bit	D7:D6	D5:D3	D2	D1	D0
Name	SYNC	-	OSD	B_EN	SSD
Default	00	000	0	0	0

The Configuration Register sets operating mode of IS31FL3737.

When SYNC bits are set to “01”, the IS31FL3737 is configured as the master clock source and the SYNC pin will generate a clock signal distributed to the clock slave devices. To be configured as a clock slave device and accept an external clock input the slave device’s SYNC bits must be set to “10”.

When OSD set high, open/short detection will be trigger once, the user could trigger OS detection again by set OSD from “0” to “1”.

When B_EN enable, those dots select working in ABM-x mode will start to run the pre-established timing. If it is disabled, all dots work in PWM mode. Following Figure 16 to enable the Auto Breath mode. When SSD is “0”, IS31FL3737 works in software shutdown mode and to normal operate the SSD bit should set to “1”.

IS31FL3737

SYNC Synchronize Configuration
 00/11 High Impedance
 01 Master
 10 Slave

OSD Open/Short Detection Enable Bit
 0 Disable open/short detection
 1 Enable open/short detection

B_EN Auto Breath Enable
 0 PWM Mode Enable
 1 Auto Breath Mode Enable

SSD Software Shutdown Control
 0 Software shutdown
 1 Normal operation

T1 T1 Setting
 000 0.21s
 001 0.42s
 010 0.84s
 011 1.68s
 100 3.36s
 101 6.72s
 110 13.44s
 111 26.88s

T2 T2 Setting
 0000 0s
 0001 0.21s
 0010 0.42s
 0011 0.84s
 0100 1.68s
 0101 3.36s
 0110 6.72s
 0111 13.44s
 1000 26.88s
 Others Unavailable

Table 14 01h Global Current Control Register

Bit	D7:D0
Name	GCCx
Default	0000 0000

The Global Current Control Register modulates all CSx (x=1~12) DC current which is noted as I_{OUT} in 256 steps.

I_{OUT} is computed by the Formula (3):

$$I_{OUT} = \frac{840}{R_{EXT}} \times \frac{GCC}{256} \quad (3)$$

$$GCC = \sum_{n=0}^7 D[n] \cdot 2^n$$

Where D[n] stands for the individual bit value, 1 or 0, in location n, R_{EXT} is the external resistor of R_{EXT} pin.

For example: if D7:D0 = 1011 0101,

$$I_{OUT} = \frac{2^0 + 2^2 + 2^4 + 2^5 + 2^7}{256} \times \frac{840}{R_{EXT}}$$

Table 15 02h, 06h, 0Ah Auto Breath Control Register 1 of ABM-x

Bit	D7:D5	D4:D1	D0
Name	T1	T2	-
Default	000	0000	0

Auto Breath Control Register 1 set the T1&T2 time in Auto Breath Mode.

Table 16 03h, 07h, 0Bh Auto Breath Control Register 2 of ABM-x

Bit	D7:D5	D4:D1	D0
Name	T3	T4	-
Default	000	0000	0

Auto Breath Control Register 2 set the T3&T4 time in Auto Breath Mode.

T3 T3 Setting
 000 0.21s
 001 0.42s
 010 0.84s
 011 1.68s
 100 3.36s
 101 6.72s
 110 13.44s
 111 26.88s

T4 T4 Setting
 0000 0s
 0001 0.21s
 0010 0.42s
 0011 0.84s
 0100 1.68s
 0101 3.36s
 0110 6.72s
 0111 13.44s
 1000 26.88s
 1001 53.76s
 1010 107.52s
 Others Unavailable

IS31FL3737

Table 17 04h, 08h, 0Ch Auto Breath Control Register 3 of ABM-x

Bit	D7:D6	D5:D4	D3:D0
Name	LE	LB	LTA
Default	00	00	0000

Total loop times= LTA ×256 + LTB.

For example, if LTA=2, LTB=100, the total loop times is 256×2+100= 612 times.

For the counting of breathing times, do follow Figure 16 to enable the Auto Breath Mode.

If the loop start from T4,

T4->T1->T2->T3(1)->T4->T1->T2->T3(2)->T4->T1->... and so on.

If the loop not start from T4,

Tx->T3(1) ->T4->T1->T2->T3(2)->T4-> T1->... and so on.

If the loop ends at off state (End of T3), the LED will be off state at last. If the loop ends at on state (End of T1), the LED will run an extra T4&T1, which are not included in loop.

- LB** Loop Beginning Time
- 00 Loop begin from T1
 - 01 Loop begin from T2
 - 10 Loop begin from T3
 - 11 Loop begin from T4

- LE** Loop End Time
- 00 Loop end at off state (End of T3)
 - 01 Loop end at on state (End of T1)
 - Others Unavailable

- LTA** 8-11 Bits Of Loop Times
- 0000 Endless loop
 - 0001 1
 - 0010 2
 -
 - 1111 15

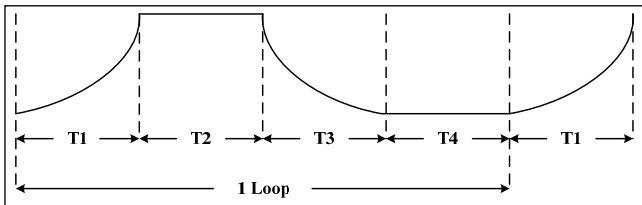

Figure 11 Auto Breathing Function

Table 18 05h, 09h, 0Dh Auto Breath Control Register 4 of ABM-x

Bit	D7:D0
Name	LTB
Default	0000 0000

Total loop times= LTA ×256 + LTB.

For example, if LTA=2, LTB=100, the total loop times is 256×2+100= 612 times.

- LTB** 0-7 Bits Of Loop Times
- 0000 0000 Endless loop
 - 0000 0001 1
 - 0000 0010 2
 -
 - 1111 1111 255

0Eh Time Update Register (02h~0Dh)

The data sent to the time registers (02h~0Dh) will be stored in temporary registers. A write operation of "0000 0000" data to the Time Update Register is required to update the registers (02h~0Dh). Please follow Figure 16 to enable the Auto Breath mode and update the time parameters.

Table 19 0Fh SWy Pull-Up Resistor Selection Register

Bit	D7:D3	D2:D0
Name	-	PUR
Default	00000	000

Set pull-up resistor for SWy.

- PUR** SWy Pull-up Resistor Selection Bit
- 000 No pull-up resistor
 - 001 0.5kΩ pull-up in t_{NOL}
 - 010 1.0kΩ pull-up in t_{NOL}
 - 011 2.0kΩ pull-up in t_{NOL}
 - 100 4.0kΩ pull-up in t_{NOL}
 - 101 8.0kΩ pull-up in t_{NOL}
 - 110 16kΩ pull-up in t_{NOL}
 - 111 32kΩ pull-up in t_{NOL}

Table 20 10h CSx Pull-Down Resistor Selection Register

Bit	D7:D3	D2:D0
Name	-	PDR
Default	00000	000

Set the pull-down resistor for CSx.

IS31FL3737

PDR	CSx Pull-down Resistor Selection Bit
000	No pull-down resistor
001	0.5k Ω pull-down in t_{NOL}
010	1.0k Ω pull-down in t_{NOL}
011	2.0k Ω pull-down in t_{NOL}
100	4.0k Ω pull-down in t_{NOL}
101	8.0k Ω pull-down in t_{NOL}
110	16k Ω pull-down in t_{NOL}
111	32k Ω pull-down in t_{NOL}

11h Reset Register

Once user read the Reset Register, IS31FL3737 will reset all the IS31FL3737 registers to their default value. On initial power-up, the IS31FL3737 registers are reset to their default values for a blank display.

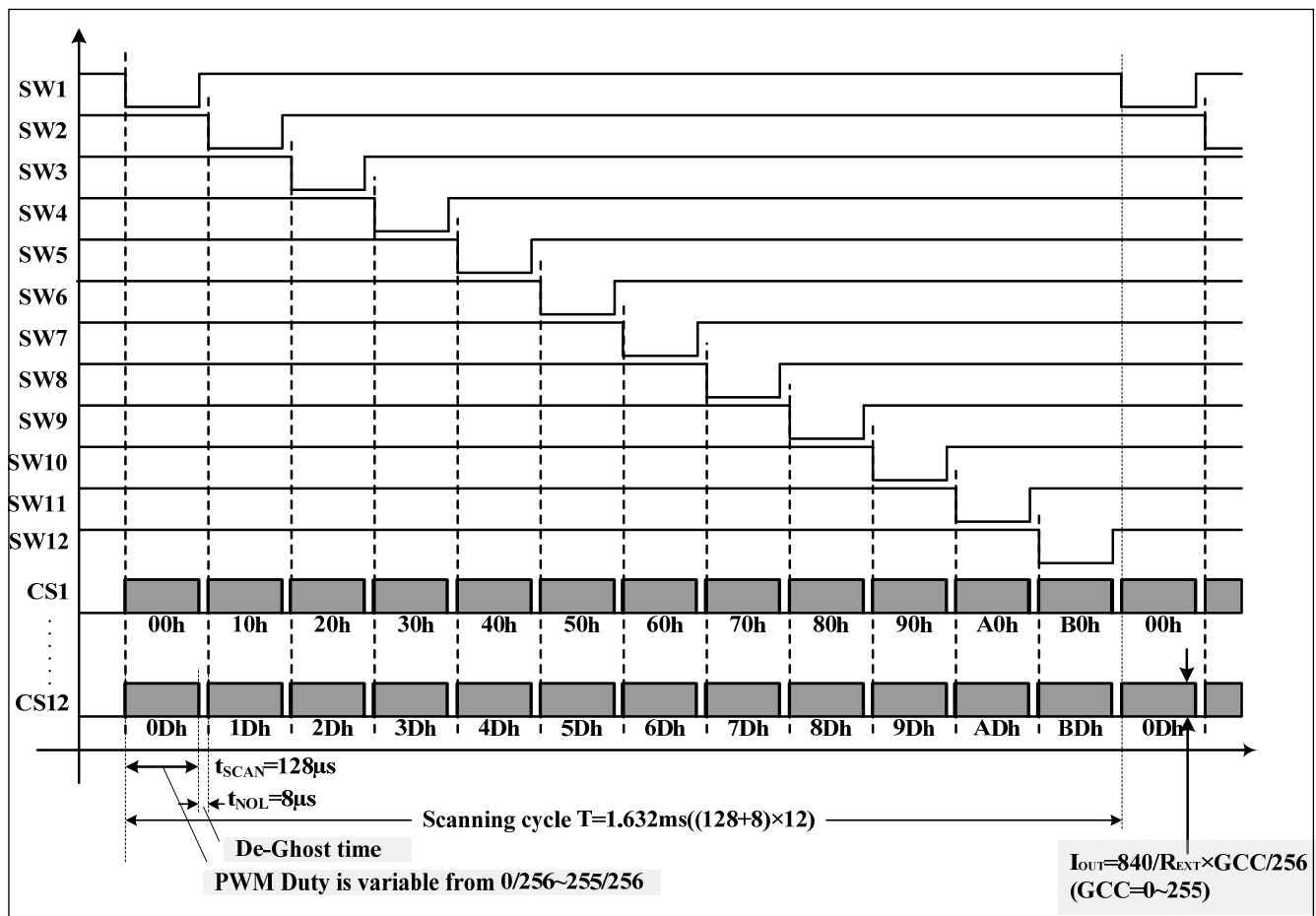

Figure 12 Scanning Timing

SCANNING TIMING

As shown in Figure 12, the SW1~SW12 is turned on by serial, LED is driven 12 by 12 within the SW_y (x=1~12) on time (SW_y, y=1~12) is sink and pull low when LED on), including the non-overlap blanking time during scan, the duty cycle of SW_y (active low, y=1~12) is:

$$Duty = \frac{128\mu s}{(128\mu s + 8\mu s)} \times \frac{1}{12} = \frac{1}{12.75} \quad (2)$$

Where 128µs is t_{SCAN}, the period of scanning and 8µs is t_{NOL}, the non-overlap time.

EXTERNAL RESISTOR (R_{EXT})

The output current for each CS_x can be set by a single external resistor, R_{EXT}, as described in Formula (3).

$$I_{OUT} = \frac{840}{R_{EXT}} \times \frac{GCC}{256} \quad (3)$$

GCC is Global Current Control Register (PG3, 01h) data showing in Table 14.

PWM CONTROL

After setting the I_{OUT} and GCC, the brightness of each LEDs (LED average current (I_{LED})) can be modulated with 256 steps by PWM Register, as described in Formula (1).

$$I_{LED} = \frac{PWM}{256} \times I_{OUT} \times Duty \quad (1)$$

Where PWM is PWM Registers (PG1, 00h~BDh) data showing in Table 10.

For example, in Figure 1, R_{EXT}=20kΩ, if PWM=255, and GCC=255, then

$$I_{LED} = \frac{255}{256} \times \frac{840}{20k\Omega} \times \frac{255}{256} \times \frac{1}{12.75} = 3.29mA$$

Writing new data continuously to the registers can modulate the brightness of the LEDs to achieve a breathing effect.

LED AVERAGE CURRENT (I_{LED})

As described in Formula (1), the LED average current (I_{LED}) is effected by 3 factors:

IS31FL3737

1. R_{EXT} , resistor which is connected R_EXT pin and GND. R_{EXT} sets the current of all CSx (x=1~12) based on Formula (3).
2. Global Current Control Register (PG3, 01h). This register adjusts all CSx (x=1~12) output currents by 256 steps as shown in Formula (3).
3. PWM Registers (PG1, 00h~BFh), every LED has an own PWM register. PWM Registers adjust individual LED average current by 256 steps as shown in Formula (1).

GAMMA CORRECTION

In order to perform a better visual LED breathing effect we recommend using a gamma corrected PWM value to set the LED intensity. This results in a reduced number of steps for the LED intensity setting, but causes the change in intensity to appear more linear to the human eye.

Gamma correction, also known as gamma compression or encoding, is used to encode linear luminance to match the non-linear characteristics of display. Since the IS31FL3737 can modulate the brightness of the LEDs with 256 steps, a gamma correction function can be applied when computing each subsequent LED intensity setting such that the changes in brightness matches the human eye's brightness curve.

Table 21 32 Gamma Steps with 256 PWM Steps

C(0)	C(1)	C(2)	C(3)	C(4)	C(5)	C(6)	C(7)
0	1	2	4	6	10	13	18
C(8)	C(9)	C(10)	C(11)	C(12)	C(13)	C(14)	C(15)
22	28	33	39	46	53	61	69
C(16)	C(17)	C(18)	C(19)	C(20)	C(21)	C(22)	C(23)
78	86	96	106	116	126	138	149
C(24)	C(25)	C(26)	C(27)	C(28)	C(29)	C(30)	C(31)
161	173	186	199	212	226	240	255

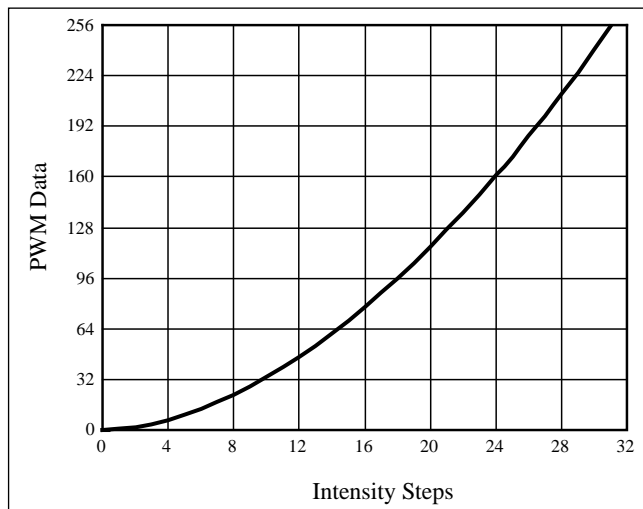

Figure 13 Gamma Correction (32 Steps)

Choosing more gamma steps provides for a more continuous looking breathing effect. This is useful for very long breathing cycles. The recommended configuration is defined by the breath cycle T. When T=1s, choose 32 gamma steps, when T=2s, choose 64 gamma steps. The user must decide the final number of gamma steps not only by the LED itself, but also based on the visual performance of the finished product.

Table 22 64 Gamma Steps with 256 PWM Steps

C(0)	C(1)	C(2)	C(3)	C(4)	C(5)	C(6)	C(7)
0	1	2	3	4	5	6	7
C(8)	C(9)	C(10)	C(11)	C(12)	C(13)	C(14)	C(15)
8	10	12	14	16	18	20	22
C(16)	C(17)	C(18)	C(19)	C(20)	C(21)	C(22)	C(23)
24	26	29	32	35	38	41	44
C(24)	C(25)	C(26)	C(27)	C(28)	C(29)	C(30)	C(31)
47	50	53	57	61	65	69	73
C(32)	C(33)	C(34)	C(35)	C(36)	C(37)	C(38)	C(39)
77	81	85	89	94	99	104	109
C(40)	C(41)	C(42)	C(43)	C(44)	C(45)	C(46)	C(47)
114	119	124	129	134	140	146	152
C(48)	C(49)	C(50)	C(51)	C(52)	C(53)	C(54)	C(55)
158	164	170	176	182	188	195	202
C(56)	C(57)	C(58)	C(59)	C(60)	C(61)	C(62)	C(63)
209	216	223	230	237	244	251	255

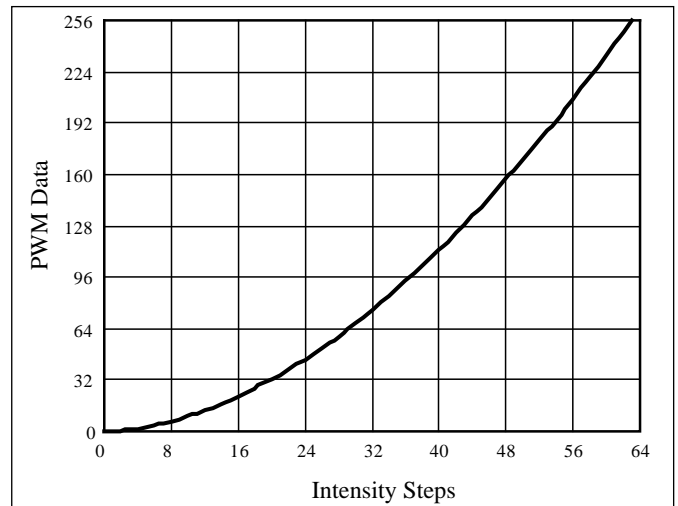

Figure 14 Gamma Correction (64 Steps)

Note: The data of 32 gamma steps is the standard value and the data of 64 gamma steps is the recommended value.

OPERATING MODE

Each dot of IS31FL3737 has two selectable operating modes, PWM Mode and Auto Breath Mode.

PWM Mode

By setting the Auto Breath Mode Register bits of the Page 2 (PG2, 00h~BFh) to "00", or disable the B_EN bit of Configure Register (PG3, 00h), the IS31FL3737

IS31FL3737

operates in PWM Mode. The brightness of each LED can be modulated with 256 steps by PWM registers. For example, if the data in PWM Register is “0000 0100”, then the PWM is the fourth step.

Writing new data continuously to the registers can modulate the brightness of the LEDs to achieve a breathing effect.

Auto Breath Mode

By setting the B_EN bit of the Configuration Register (PG3, 00h) to “1”, breath function enables. When set the B_EN bit to “0”, breath function disables.

By setting the Auto Breath Mode Register bits of the Page 2 (PG2, 00h~BFh) to “01” (ABM-1), “10” (ABM-2) or “11” (ABM-3), the IS31FL3737 operates in Auto Breath Mode.

IS31FL3737 has three auto breath modes, Auto Breath Mode 1, Auto Breath Mode 2 and Auto Breath Mode 3. Each ABM has T1, T2, T3 and T4, as shown below:

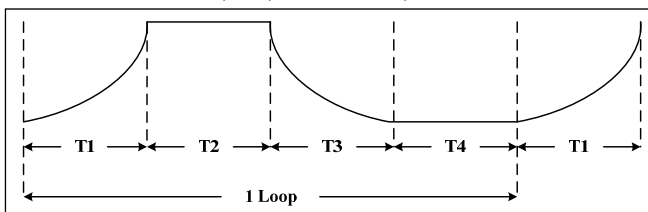

Figure 15 Auto Breathing Function

T1/T3 is variable from 0.21s to 26.88s, T2/T4 is variable from 0s to 26.88s, for each loop, the start point can be T1~T4 and the stop point can be on state (T2) and off state (T4), also the loop time can be set to 1~2¹² times or endless. Each LED can select ABM-1~ABM-3 to work.

The setting of ABM-1~ABM-3 (PG2, 02h~0Dh) need to write the 0Eh in PG3 to update before effective.

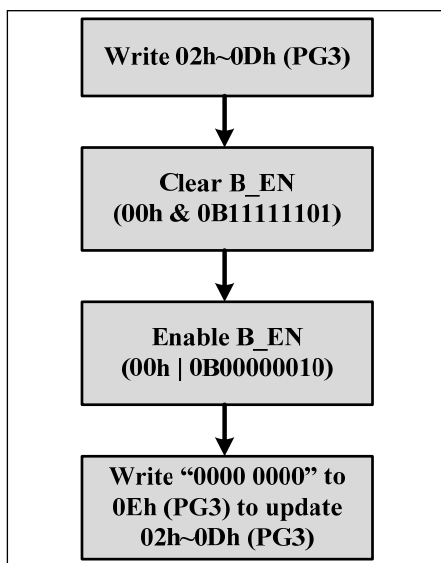

Figure 16 Enable Auto Breath Mode

If not follow this flow, first loop’s start point may be wrong.

OPEN/SHORT DETECT FUNCTION

IS31FL3737 has open and short detect bit for each LED.

By setting the OSD bit of the Configuration Register (PG3, 00h) from “0” to “1”, the LED Open Register and LED Short Register will start to store the open/short information and after at least 2 scanning cycle (3.264ms) the MCU can get the open/short information by reading the 18h~2fh/30h~47h, for those dots are turned off via LED On/Off Registers (PG0, 00h~17h), the open/short data will not get refreshed when setting the OSD bit of the Configuration Register (PG3, 00h) from “0” to “1”.

The Global Current Control Register (PG3, 01h) needs to set to 0x01 in order to get the right open/short data.

The detect action is one-off event and each time before reading out the open/short information, the OSD bit of the Configuration Register (PG3, 00h) need to be set from “0” to “1” (clear before set operation).

INTERRUPT CONTROL

IS31FL3737 has an INTB pin, by setting the Interrupt Mask Register (F0h), it can be the flag of LED open, LED short or the finish flag of ABM-1, ABM-2, and ABM-3.

For example, if the IO bit of the Interrupt Mask Register (F0h) set to “1”, when LED open happens, the INTB will pull be pulled low and the OB bit of Interrupt Status Register (F1h) will store open status at the same time.

The INTB pin will be pulled high after reading the Interrupt Status Register (F1h) operation or it will be pulled high automatically after it stays low for 8ms (Typ.) if the IAC bit of Interrupt Mask Register (F0h) is set to “1”. The bits of Interrupt Status Register (F1h) will be reset to “0” after INTB pin pulled high.

SYNCHRONIZE FUNCTION

SYNC bits of the Configuration Register (PG3, 00h) sets SYNC pin input or output synchronize clock signal. It is used for more than one part working synchronize. When SYNC bits are set to “01”, SYNC pin output synchronize clock to synchronize other parts as master. When SYNC bits are set to “10”, SYNC pin input synchronize clock and work synchronization with this input signal as slave. When SYNC bits are set to “00/11”, SYNC pin is high impedance, and synchronize function is disabled. SYNC bit default state is “00” and SYNC pin is high impedance when power up.

DE-GHOST FUNCTION

The “ghost” term is used to describe the behavior of an LED that should be OFF but instead glows dimly when another LED is turned ON. A ghosting effect

IS31FL3737

typically can occur when multiplexing LEDs. In matrix architecture any parasitic capacitance found in the constant-current outputs or the PCB traces to the LEDs may provide sufficient current to dimly light an LED to create a ghosting effect.

To prevent this LED ghost effect, the IS31FL3737 has integrated pull-up resistors for each SW_y (y=1~12) and pull-down resistors for each CS_x (x=1~12). Select the right SW_y pull-up resistor (PG3, 0Fh) and CS_x pull-down resistor (PG3, 10h) which eliminates the ghost LED for a particular matrix layout configuration.

Typically, selecting the 32kΩ will be sufficient to eliminate the LED ghost phenomenon.

The SW_y pull-up resistors and CS_x pull-down resistors are active only when the CS_x/SW_y outputs are in the OFF state and therefore no power is lost through these resistors

I2C RESET

The I2C will be reset if the IICRST pin is pull-high, when normal operating the I2C bus, the IICRST pin need to keep low.

SHUTDOWN MODE

Shutdown mode can be used as a means of reducing power consumption. During shutdown mode all registers retain their data.

Software Shutdown

By setting SSD bit of the Configuration Register (PG3, 00h) to "0", the IS31FL3737 will operate in software shutdown mode. When the IS31FL3737 is in software shutdown, all current sources are switched off, so that the matrix is blanked. All registers can be operated. Typical current consume is 3μA.

Hardware Shutdown

The chip enters hardware shutdown when the SDB pin is pulled low. All analog circuits are disabled during hardware shutdown, typical the current consume is 3μA.

The chip releases hardware shutdown when the SDB pin is pulled high. During hardware shutdown state Function Register can be operated.

If V_{CC} has risk drop below 1.75V but above 0.1V during SDB pulled low, please re-initialize all Function Registers before SDB pulled high.

TEST MODE

In order to test or adjust some items of the IC, the IS31FL3737 has some registers in test mode. In test mode, the scanning of the SW can be stopped and some parameters can be adjusted by setting the register bits of certain registers. Test mode is not allowed to enter in normal operations, but in some bad conditions like keep doing EFT (Electrical Fast Transient) test in power system, very low risk that the

I2C bus will mis-write those registers and let the IC stop scanning, and keep working in test mode. So we recommend for white goods applications, writing these registers repeatedly like every 5 seconds to prevent the IC entering test mode without quitting.

1. Write FDh with 0x03 enter page 3, if it is in page 3, skip this step.
2. Write E0h with 0x01 to enter test mode
3. Write E1h with 0x00 to quit the 'SW_y stop scanning' status.
4. Write E2h with 0x00 to default value
5. Write E3h with 0x00 to default value
6. Write E0h with 0x01 to quit and prevent entering test mode.

Below are definition of test related registers.

Table 21 E0h Test Mode Enable Register

Bit	D7:D1	D0
Name	-	TEST_PT
Default	0000 000	0

Test mode enable register has two functions, first it is the entrance of the test mode, second it also protect the other test registers been miswritten.

TEST_PT	Test mode protect bit
0	Disable test mode, E1h~E3h cannot be accessed
1	Enable test mode, E1h~E3h can be accessed

Table 22 E1h Test Mode Data Register 1

Bit	D7:D4	D3:D0
Name	-	SW_S
Default	0000	0000

When normal operation, SW₁~SW₁₂ are always scanning as the timing of Figure 12, if SW_S bits are set to "0001"~"0111", SW_y stop scanning' status and one of the SW_y will be selected as the power output all the time.

SW_S	SW _y setting
0001	SW ₁ always on, other SW _y float
0010	SW ₂ always on, other SW _y float
0011	SW ₃ always on, other SW _y float
0100	SW ₄ always on, other SW _y float
0101	SW ₅ always on, other SW _y float
0110	SW ₆ always on, other SW _y float
0111	SW ₇ always on, other SW _y float
1000	SW ₈ always on, other SW _y float
1001	SW ₉ always on, other SW _y float
1010	SW ₁₀ always on, other SW _y float
1011	SW ₁₁ always on, other SW _y float
1100	SW ₁₂ always on, other SW _y float

IS31FL3737

Table 23 E2h Test Mode Data Register 2

Bit	D7:D3	D2:D0
Name	-	TRIM_CS
Default	00	000

Table 24 E3h Test Mode Data Register 3

Bit	D7:D4	D3:D0
Name	TRIM_BG	TRIM_OSC
Default	0000	0000

Data register 2 and 3 can change the voltage of R_EXT pin (TRIM_BG), adjust the internal oscillator frequency (TRIM_OSC) and trim the average output current of all CSx (TRIM_CS), when normal operation, these registers must keep default value, otherwise those parameters will be changed permanently.

POWER DISSIPATION

The power dissipation of the IS31FL3737 can calculate as below:

$$\begin{aligned}
 P_{3737} &= I_{PVCC} \times PV_{CC} + I_Q \times DV_{CC}(AV_{CC}) - I_{PVCC} \times V_{F(AVR)} \quad (4) \\
 &\approx I_{PVCC} \times PV_{CC} - I_{PVCC} \times V_{F(AVR)} \\
 &\approx I_{PVCC} \times (PV_{CC} - V_{F(AVR)})
 \end{aligned}$$

Where I_{PVCC} is the current of PVCC and $V_{F(AVR)}$ is the average forward of all the LED.

For example, if $R_{EXT}=20k\Omega$, $GCC=255$, $PWM=255$, $PV_{CC}=5V$, $V_{F(AVR)}=3.5V@42mA$, then the $I_{PVCC}=42mA \times 12 \times 12/12.75=474.4mA$.

$$P_{3737}=474.4mA \times (5V-3.5V)=0.806W$$

When operating the chip at high ambient temperatures, or when driving maximum load current, care must be taken to avoid exceeding the package power dissipation limits. The maximum power dissipation can be calculated using the following Equation (5):

$$P_{D(MAX)} = \frac{125^{\circ}C - 25^{\circ}C}{\theta_{JA}} \quad (5)$$

$$\text{So, } P_{D(MAX)} = \frac{125^{\circ}C - 25^{\circ}C}{31^{\circ}C/W} \approx 3.26W$$

Figure 17 shows the power derating of the IS31FL3737 on a JEDEC boards (in accordance with JESD 51-5 and JESD 51-7) standing in still air.

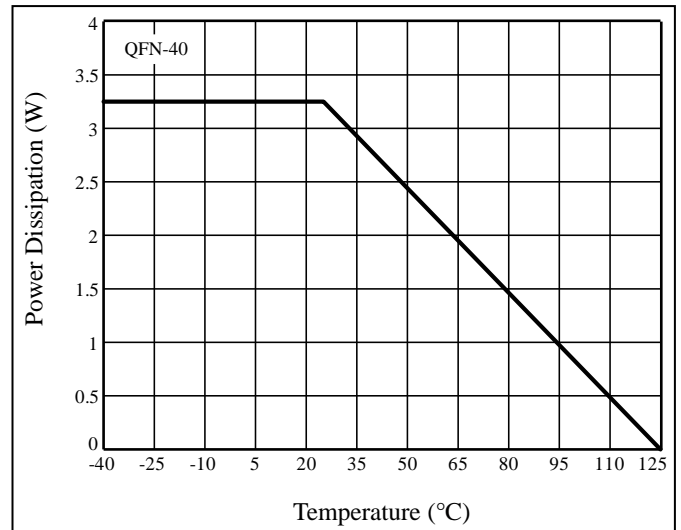

Figure 17 Dissipation Curve

LAYOUT

As described in external resistor (R_{EXT}), the chip consumes lots of power. Please consider below factors when layout the PCB.

1. The V_{CC} (PVCC, DVCC, AVCC, VIO) capacitors need to close to the chip and the ground side should well connected to the GND of the chip.
2. R_{EXT} should be close to the chip and the ground side should well connect to the GND of the chip.
3. The thermal pad should connect to ground pins and the PCB should have the thermal pad too, usually this pad should have 16 or 25 via thru the PCB to other side's ground area to help radiate the heat. About the thermal pad size, please refer to the land pattern of each package.
4. The CSx pins maximum current is 42mA ($R_{EXT}=20k\Omega$), and the SWy pins maximum current is 672mA ($R_{EXT}=20k\Omega$), the width of the trace, SWy should have wider trace than CSx.
5. In the middle of SDA and SCL trace, a ground line is recommended to avoid the effect between these two lines.

IS31FL3737

CLASSIFICATION REFLOW PROFILES

Profile Feature	Pb-Free Assembly
Preheat & Soak Temperature min (T _{smin}) Temperature max (T _{smax}) Time (T _{smin} to T _{smax}) (t _s)	150°C 200°C 60-120 seconds
Average ramp-up rate (T _{smax} to T _p)	3°C/second max.
Liquidous temperature (T _L) Time at liquidous (t _L)	217°C 60-150 seconds
Peak package body temperature (T _p)*	Max 260°C
Time (t _p)** within 5°C of the specified classification temperature (T _c)	Max 30 seconds
Average ramp-down rate (T _p to T _{smax})	6°C/second max.
Time 25°C to peak temperature	8 minutes max.

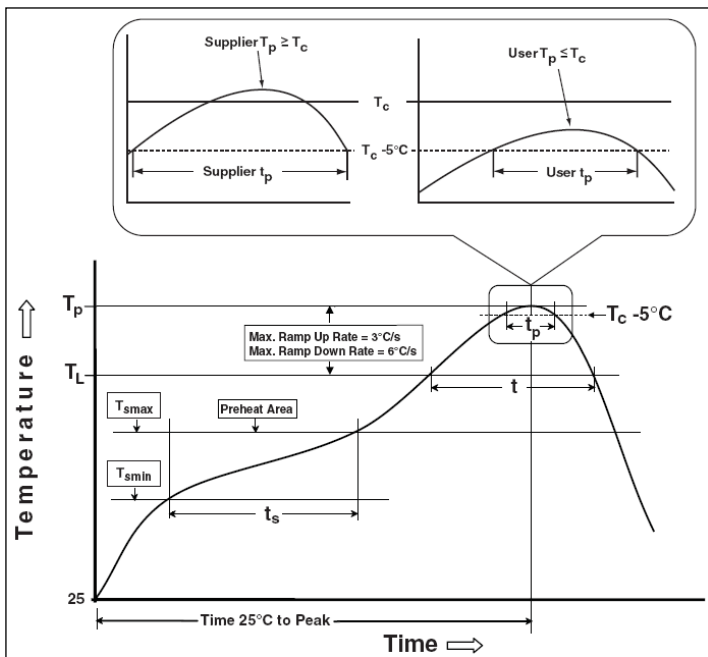
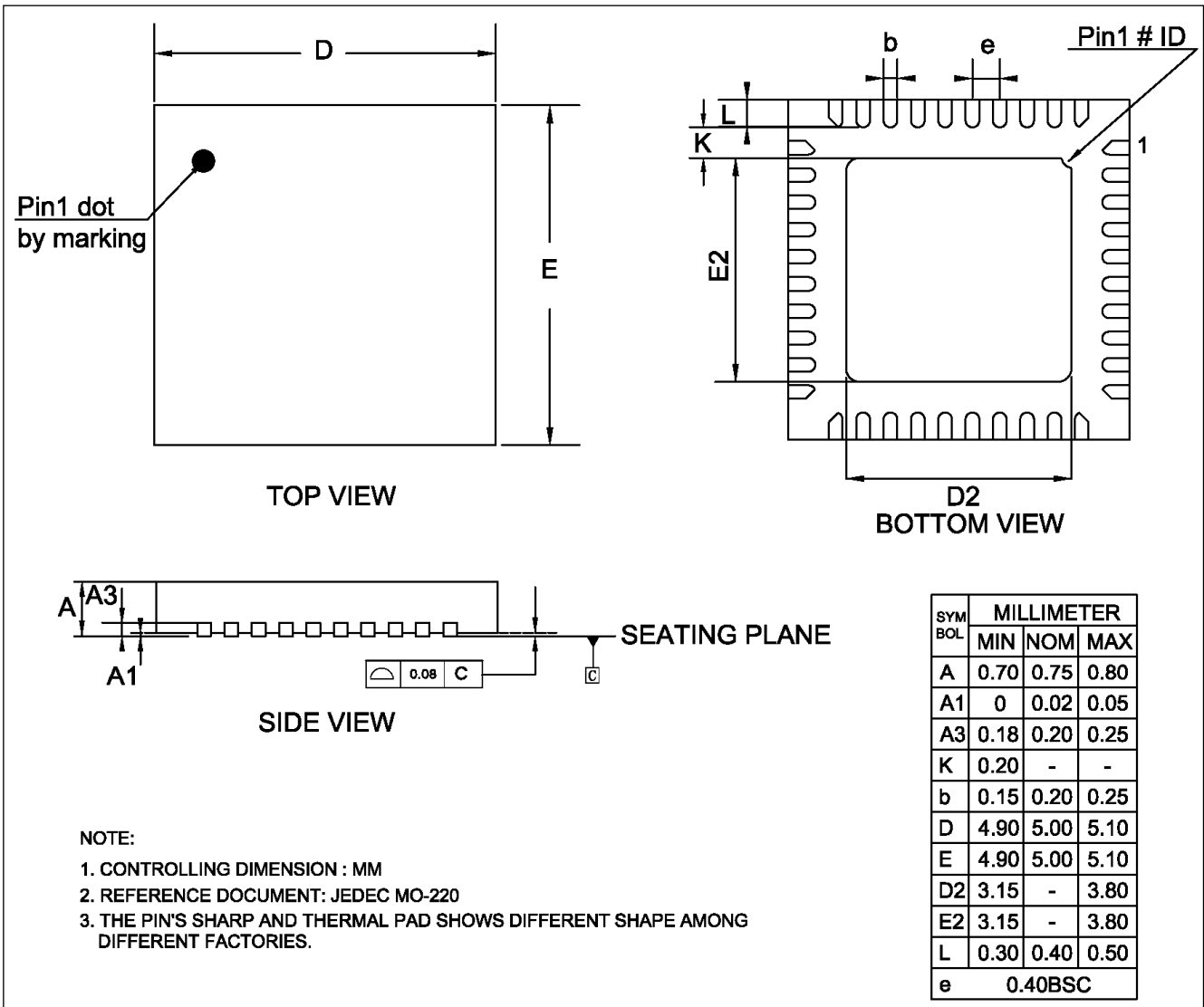

Figure 18 Classification Profile

IS31FL3737

PACKAGE INFORMATION

QFN-40



IS31FL3737

RECOMMENDED LAND PATTERN

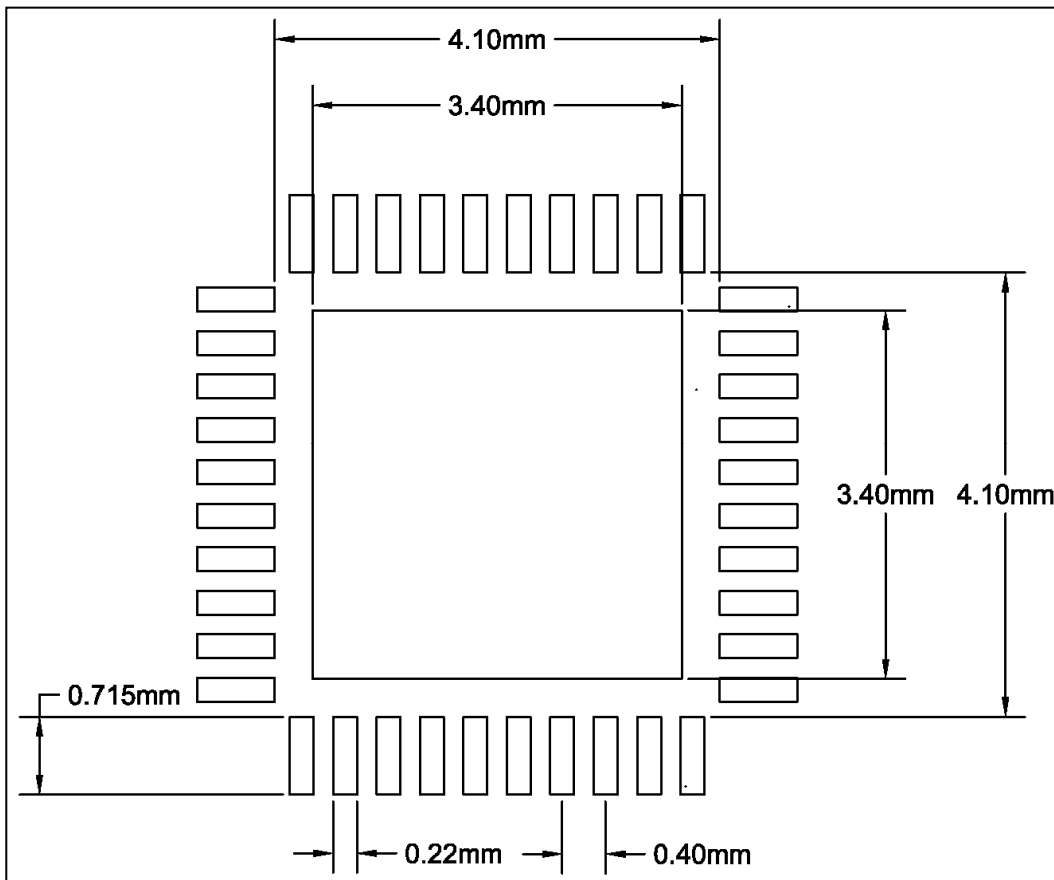

Note:

1. Land pattern complies to IPC-7351.
2. All dimensions in MM.
3. This document (including dimensions, notes & specs) is a recommendation based on typical circuit board manufacturing parameters. Since land pattern design depends on many factors unknown (eg. user's board manufacturing specs), user must determine suitability for use.



IS31FL3737

REVISION HISTORY

Revision	Detail Information	Date
0A	Initial release	2016.05.09
0B	1 Update Figure 1, 2 2 Correct a spell mistake in page 1 3 update the I_{OUT} / I_{LED} limitation	2016.06.28
A	Update I2C READING OPERATIOON section and Figure 8	2016.07.19
B	1. Update POD 2. Update land pattern	2017.07.04
C	Update typical circuit	2017.09.10
D	1. Add Test Mode section in APPLICATION INFORMATION 2. Update note 1~ note 4 3. Update R_{JA} value	2018.12.17